

MEM-CO

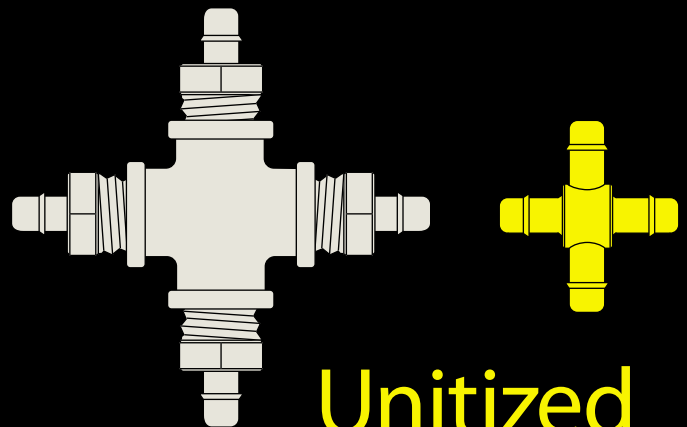

Unitized Air & Fluid Fittings, Manifolds, & Orifices

- Brass
- Electroless Nickel Plated
- Stainless Steel
- Aluminum

MEM-CO., Inc. • 45 Gigante Drive • Hampstead, NH 03841
Phone (603) 329-9633 • Fax (603) 329-4633
www.mem-co.com • Email: info@mem-co.com

What you'll find in this catalog

Thousands of fittings for plastic tubing in sizes and configurations you can't find anywhere else... fittings in brass, stainless steel, and plastic. If you can't find what you need here, ask us about making a special for you. We'll do whatever we can to help with your unique requirements!

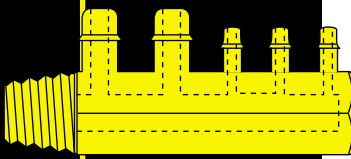
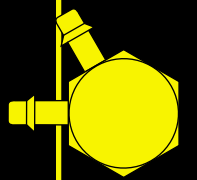
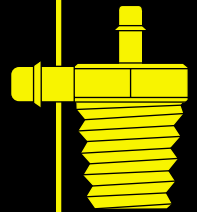
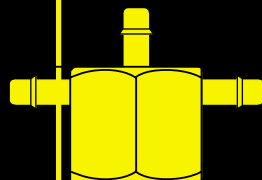
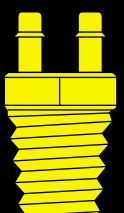
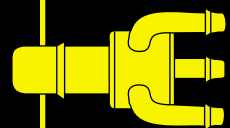
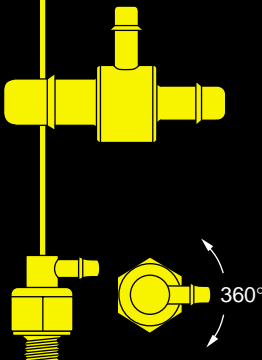

Table of Contents

Tube-to-tube barb fittings 1 - 4

- Straights and Reducing Couplings 1
- Elbows and Tees 1
- Reducing Tees 2
- Parallel Run L-Tees 3
- Parallel Run Reducing L-Tees 3
- Crosses 3
- Reducing Crosses 4
- Manifold, In-Line Reducing 4
- Manifold, Stainless Steel 27
- "Y" Fittings 4

NEW: 3-56 Male thread-to-tube 30

NEW: 6-32 Male thread-to-tube 30

NEW: 8-32 Male thread-to-tube 30

10-32 Male thread-to-tube 5, 6

- with O-Ring Seal 5
- with Captive Rubber Gasket 5
- Elbows and Tees 5
- Extension, plugs, Caps 5
- Adjustable Elbows & Tees 6
- Swivel Elbows & Tees 6

10-32 Female thread-to-tube 5

1/4-28 Male straight thread-to-tube 7

- Straights 7
- Elbows and Tees 7
- L-Tees 7

1/16 Male pipe thread-to-tube 8

- Straights 8
- Elbows and Tees 8

NEW 45° Elbows 8

- L-Tees and Reducing L-Tees 8

1/8 Male pipe thread-to-tube 9, 10

- Straights and Straight Manifolds 9
- Elbows & L-Tees 9
- Reducing L-Tees 9
- Tees and Reducing Tees 10
- Combo Tees (3 branches) 10
- V-Tees 10
- Male Nipples with tube branches 10

1/8 to 1/2 NPT manifolds 27-29

1/8 NPT Swivel Nipple 18

1/4 Male pipe thread-to-tube 11, 12

- Straights and Straight Manifolds 11
- Elbows and L-Tees 11
- Reducing L-Tees 11
- Tees 12
- Combo Tees (3 branches) 12
- V-Tees 12

3/8 Male pipe thread-to-tube 13

- Straights 13
- Elbows 13
- Tees 13

1/8 Female pipe thread-to-tube 14, 15

- Straights and Straight Manifolds 14
- Elbows and 45° Elbows 14
- Tees 15
- Combo Tees (3 branches) 15
- L-Tees and V-Tees 15

1/4 Female pipe thread-to-tube 16, 17

- Straights and Straight Manifolds 16
- Elbows 16
- L-Tees 17
- Tees and Combo Tees (3 branches) 17

Adapters 23, 24

Bulkhead Fittings 17, 18

Caps & Plugs 18

NEW: F Series Fittings 25, 26

NEW: Manifolds 27-29

NEW: Orifice Fittings 24

NEW: PTF Series: 2-piece fittings 19

- Male Thread to tube
- 10-32 thru 1/2NPT 19
- tube to tube 19

Reducing Bushings 18

Small metric fittings 20, 21

- M3 x 0.5 Series 20
- M5 x 0.8 Series 20
- M6 x 1 Series 21

Stainless Steel Fittings (How to order) . . . 24

New items have been added to virtually every category of fitting in this catalog. The items are highlighted in black boxes with white text. They are easy to spot.

Using this Catalog

1. **Silver solder joints** are typical on all fabricated Memco fittings. We do **not** use soft solder joints on any of our products. The solder we use complies with FDA, NSF, and medical grades Class VT lead-free cadmium-free solder. Our solder meets the directive 2002/96/EC on waste electrical and electronic equipment (WEEE) and directive 2002/95/EC on the restricted use of certain hazardous substances in electrical and electronic equipment (ROHS).

2. The fittings in this catalog are shown at actual size for quick visual reference.

3. Product availability:

Brass... Stainless... Electroless Nickel Plated... Aluminum

All products are available in brass directly from inventory. Products are available in stainless steel but may not be carried in stock at the time of your order. Electroless nickel plating is done on a per order basis.

4. O'Ring material availability:

Standard - Buna N
Optional - EPDM, Viton, Silicone & Teflon encapsulated silicone

5. How to Order

Part numbers are listed in rows below product drawings. Line numbers for each row are used to make product cross-referencing easy. (The price list also references line numbers)

A. For Brass items: use part number shown.



Example: B1 (See line 17, page 5)

B. For stainless steel: use part # plus suffix "S/S"

Example: B1 S/S

C. For Electroless Nickel plate: Part # plus suffix "N/P"

Example: B1 N/P

C. For Aluminum: Part # plus suffix "AL" and specify clear or color anodized

Example: B1 AL Clear

6. Developing Part Numbers

Use the convenient table below to select the barb numbers (sizes) corresponding to the internal diameters of the plastic tubing being used.

Branch Barb #	Tubing I.D.	Hole Thru
045	3/64	.043
1	1/16	.055
2	.078 (2mm)	.059
2 1/2	3/32	.081
3	1/8	.089
3 1/2	5/32 (4mm)	.104
4	.170	.125
5	3/16	.140
5 1/2	7/32	.156
6	1/4	.177
7	5/16 (8mm)	.250
8	3/8	.290
10	1/2	.391

Part numbers are written with **male thread first – female thread indicated second**.

Example: 1/4 BSPT to 1/8 (F)

(Line # 94, Page 23)

Branch numbers indicate barb sizes. First number designates the branch at the 9:00 O'clock position in the drawing. The largest branch is

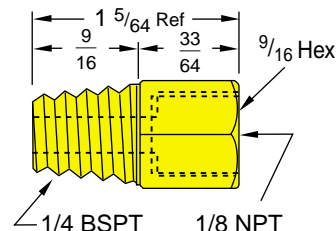

called out first. Other branch numbers follow in a clockwise direction.

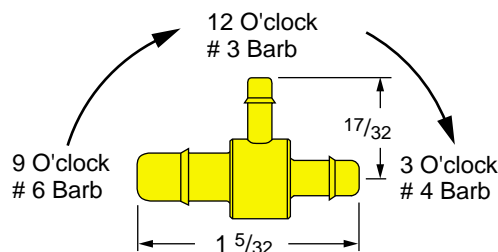

Example: RT6-3-4 (Line # 7, Page 2)

MEM-CO Model Designations are coded as follows:

B	=	Straight male thr'd to tube
C	=	coupling, tube to tube
B	=	thread to tube
L	=	elbow, barbs at 90°
T	=	tee/ (-3) = (3 way tee)
T90°	=	branches at 90°
X	=	4 way cross
R	=	reducer
RB	=	reducer bushing
RC	=	reducer coupling
RT	=	reducer tee
RX	=	reducer cross
A	=	adjustable
BK	=	bulkhead
F	=	female thread
HN	=	hex nipple
IRM	=	in-line reducer manifold
M	=	manifold
SW	=	swivel
V	=	outlets at 60°

7. Orifice Fittings

Many of our small brass and stainless fittings such as C1, C3, B1, B2, T1, T2, etc., are available as orifice fittings. In the case of Tee's, the branch and/or one end of the run may be an orifice. A cross can have as many as three orifices.

See page 24 for C Series orifice fittings.

The general dimensions in this catalog are subject to change without notice

Couplings

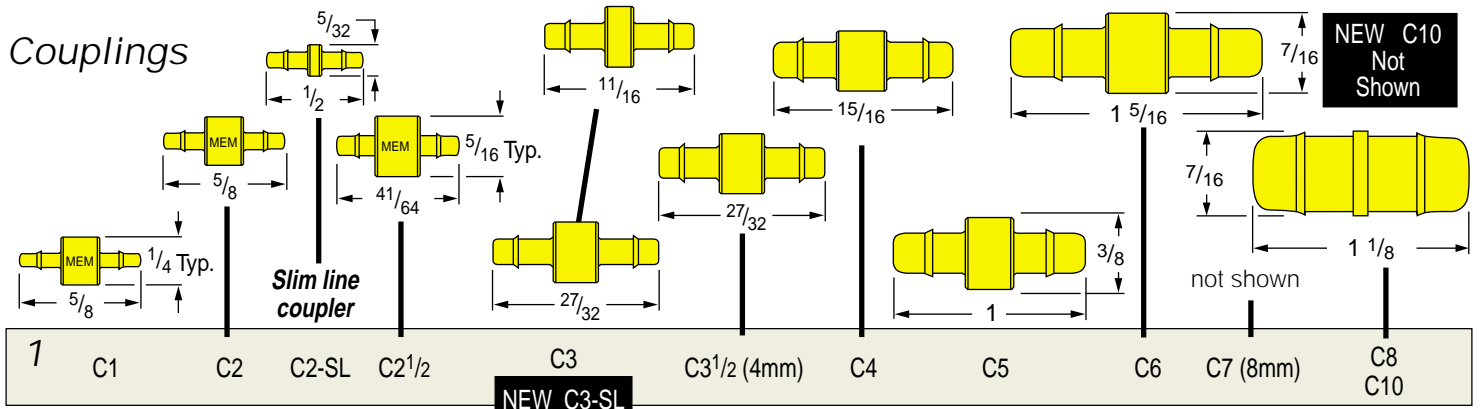

Reducing Couplings

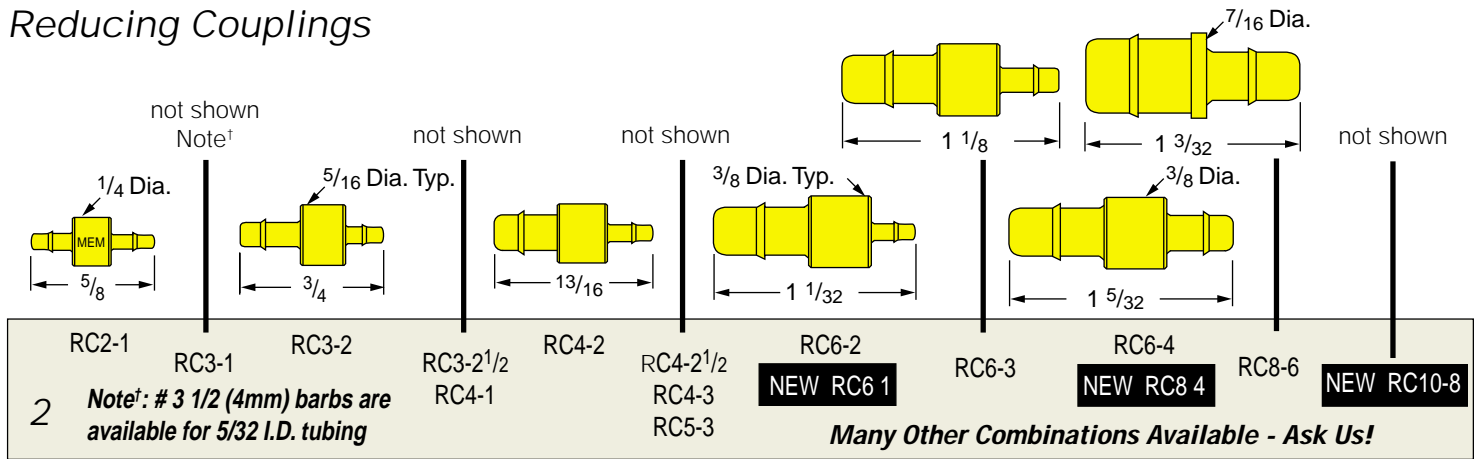

Elbows

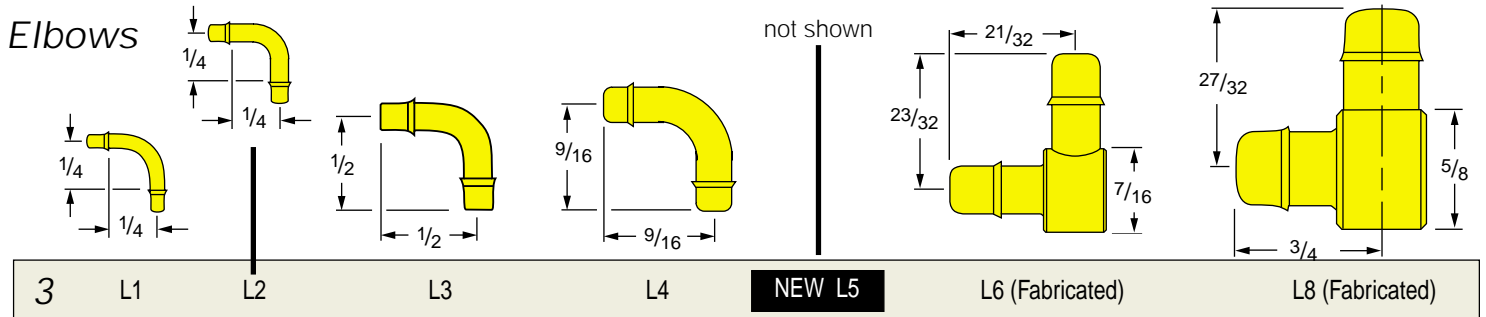

Tees

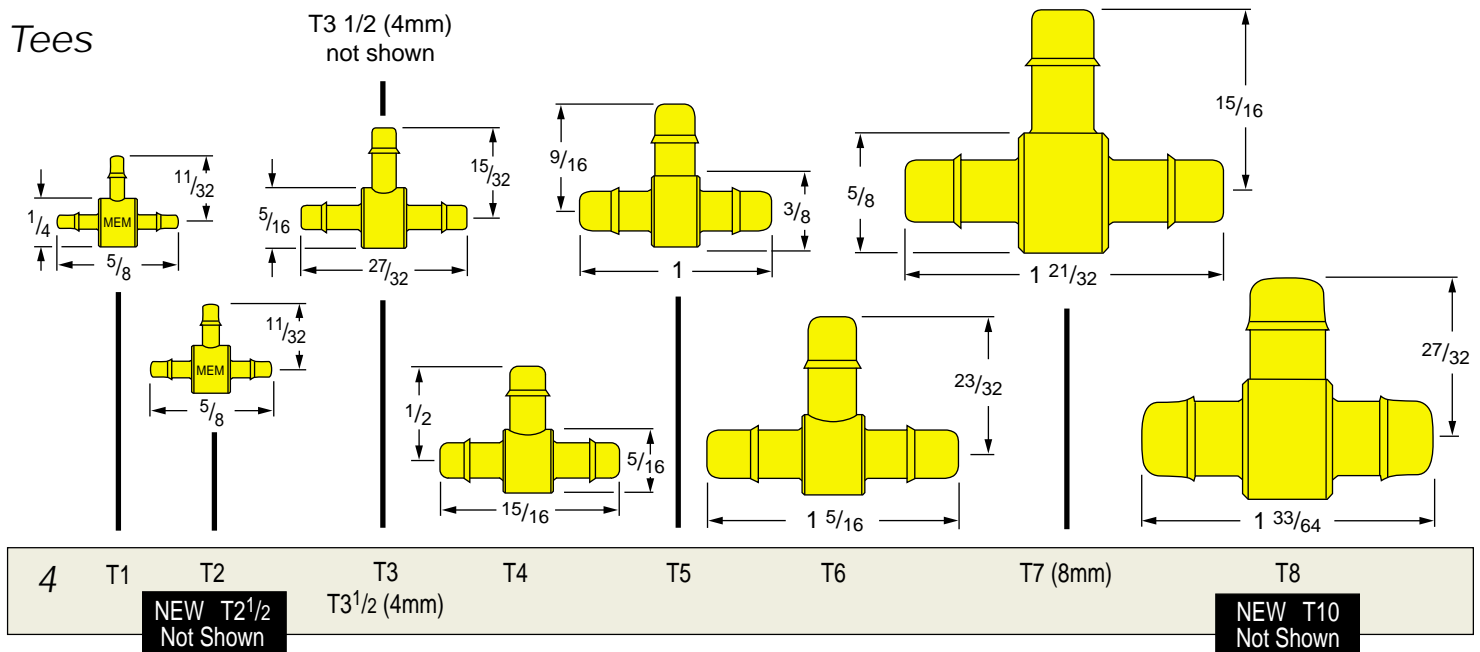

Reducing Tees

Part numbers: First number designates the branch at the 9:00 O'clock position in the drawing. The largest branch is called out first. Other branch numbers follow in a clockwise direction.

Note: # 3 1/2 bars (4mm) are available for 5/32 I.D. tubing

Reducing Tees are available in almost any combination of barb sizes!

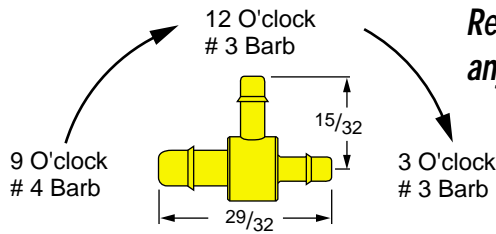

not shown

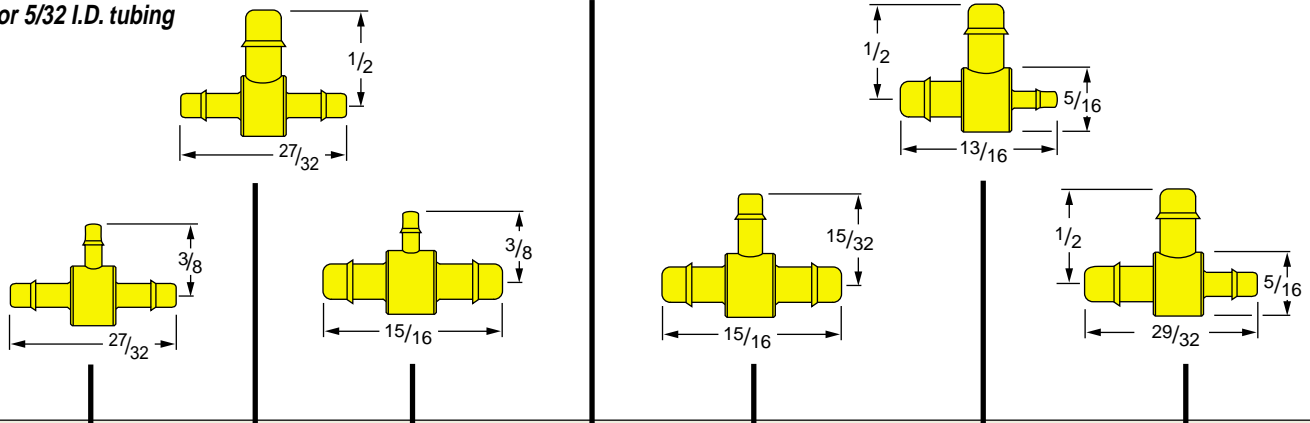

- RT1-3-1
 - RT2-1-2
 - RT3-2-2
 - RT3-1-3
 - RT3-2-3
 - RT3-2¹/₂-3
 - RT3-4-3
 - RT4-1-4
 - RT4-2-4
 - RT4-3-3
 - RT4-3-4
 - RT4-4-2
 - RT4-4-3
- 5**

Many Other Combinations Available - Ask Us!

Note: # 3 1/2 bars (4mm) are available for 5/32 I.D. tubing

not shown

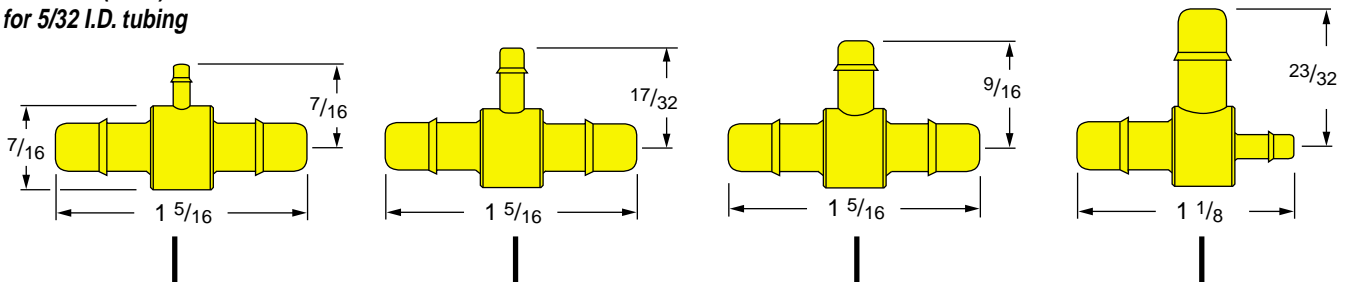

- RT5-2-5
 - RT5-3-5
 - RT6-2-6
 - RT6-3-6
 - RT6-4-6
 - RT6-6-3
- 6**

Other Combinations Available

Note: # 3 1/2 bars (4mm) are available for 5/32 I.D. tubing

not shown

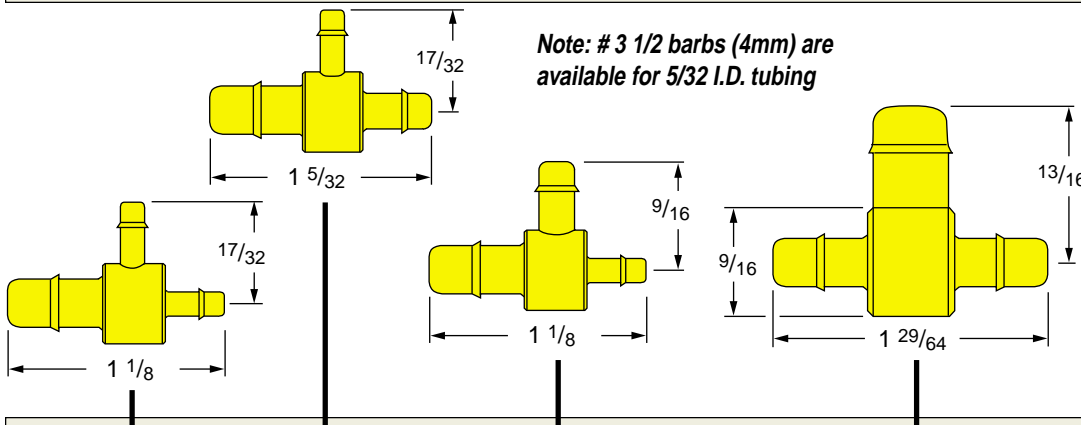

- RT6-3-3
- RT6-3-2 not shown
- RT6-2-3 not shown
- RT6-3-4
- RT6-4-3
- RT6-8-6
- RT8-2-8
- RT8-3-8
- RT8-6-8

Other Combinations Available

The NEW RT10 can have any size branches

- RT10-6-10
- RT10-7-10
- RT10-8-10
- not shown

7

Parallel Run L-Tees

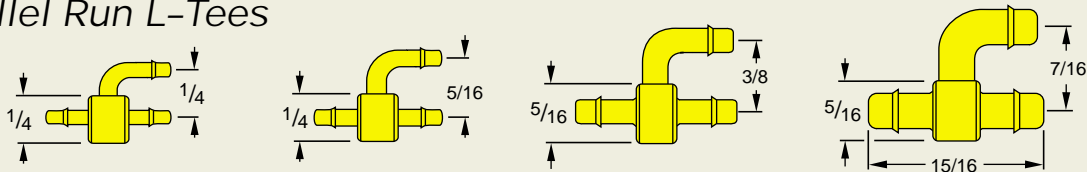

8 T1-L1-1 T2-L2-2 T3-L3-3 T4-L4-4 T5-L5-5

Parallel Run Reducing L-Tees

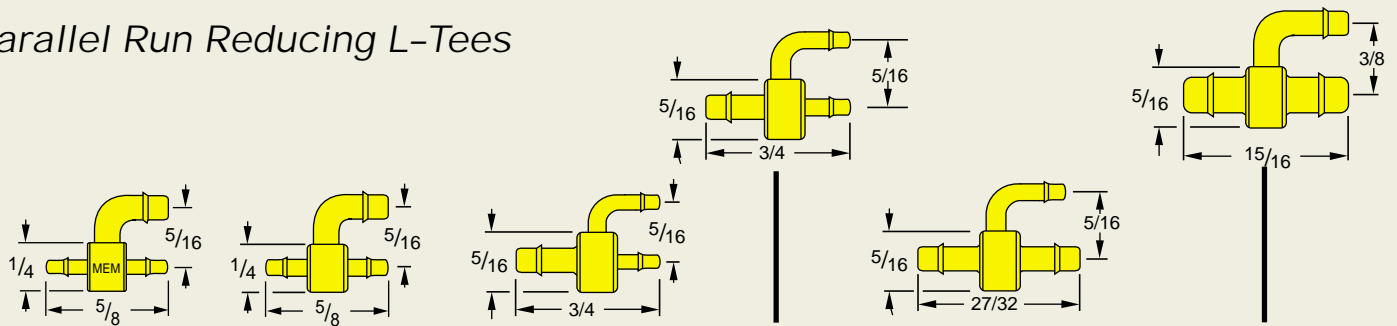

9 RT1-3L-1 RT2-3L-2 RT3-1L-1 RT3-2L-2 RT3-2L-3 RT4-3L-4

Crosses

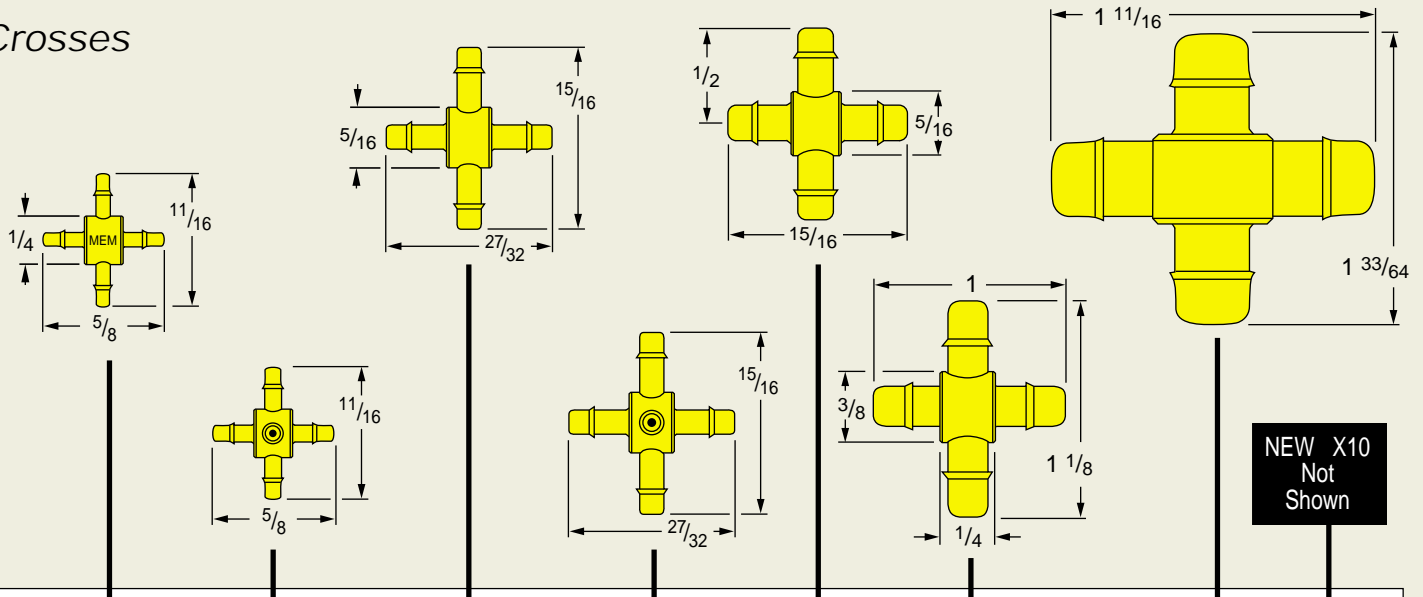

10 X1 shown X2 not shown X2 1/2 not shown X2 x 5 Five Branches X3 NEW X3 1/2 (4mm) not shown X3 x 5 Five Branches X4 X5 X6 not shown X7 (8mm) not shown X8 X10

Parallel Run Combinations

Note: Different size branches may be used

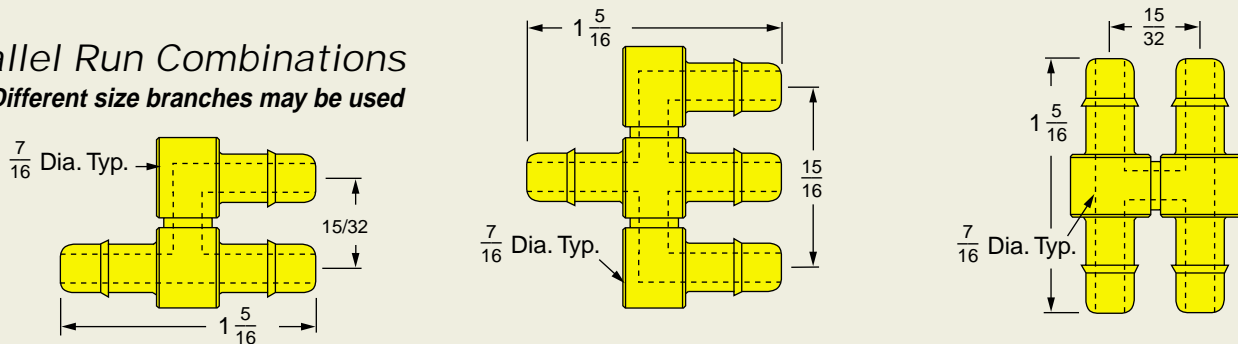

11 T-6-L6-6 IM6-L6-6-L6 H-6

Reducing Crosses

Other Combinations Available

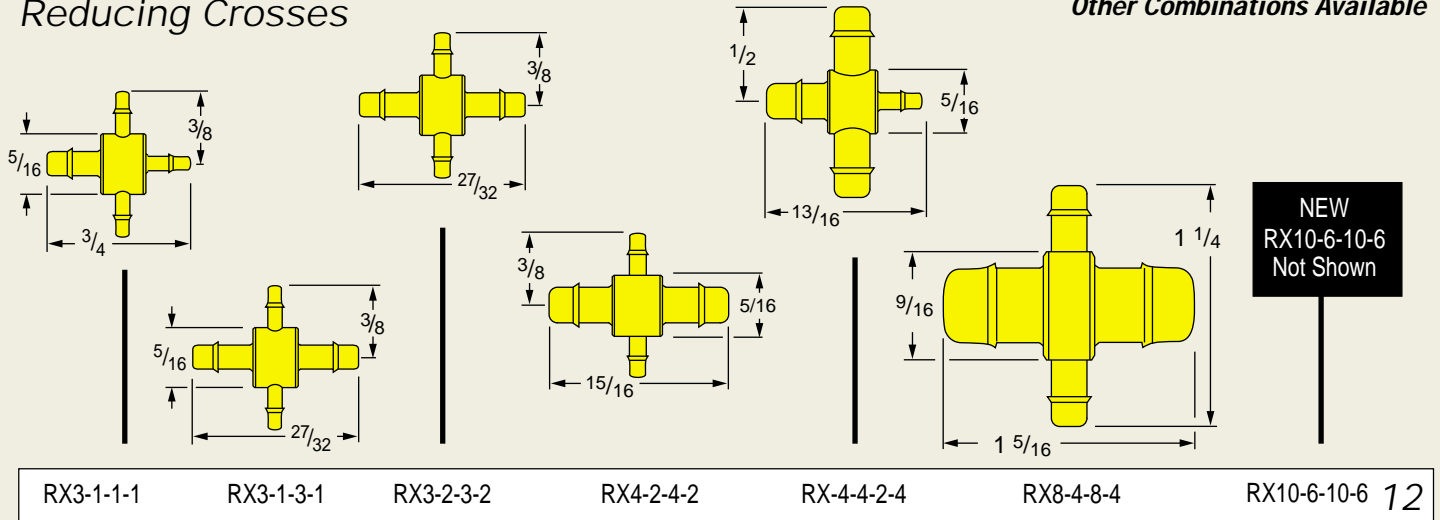

In-line Reducing Manifolds

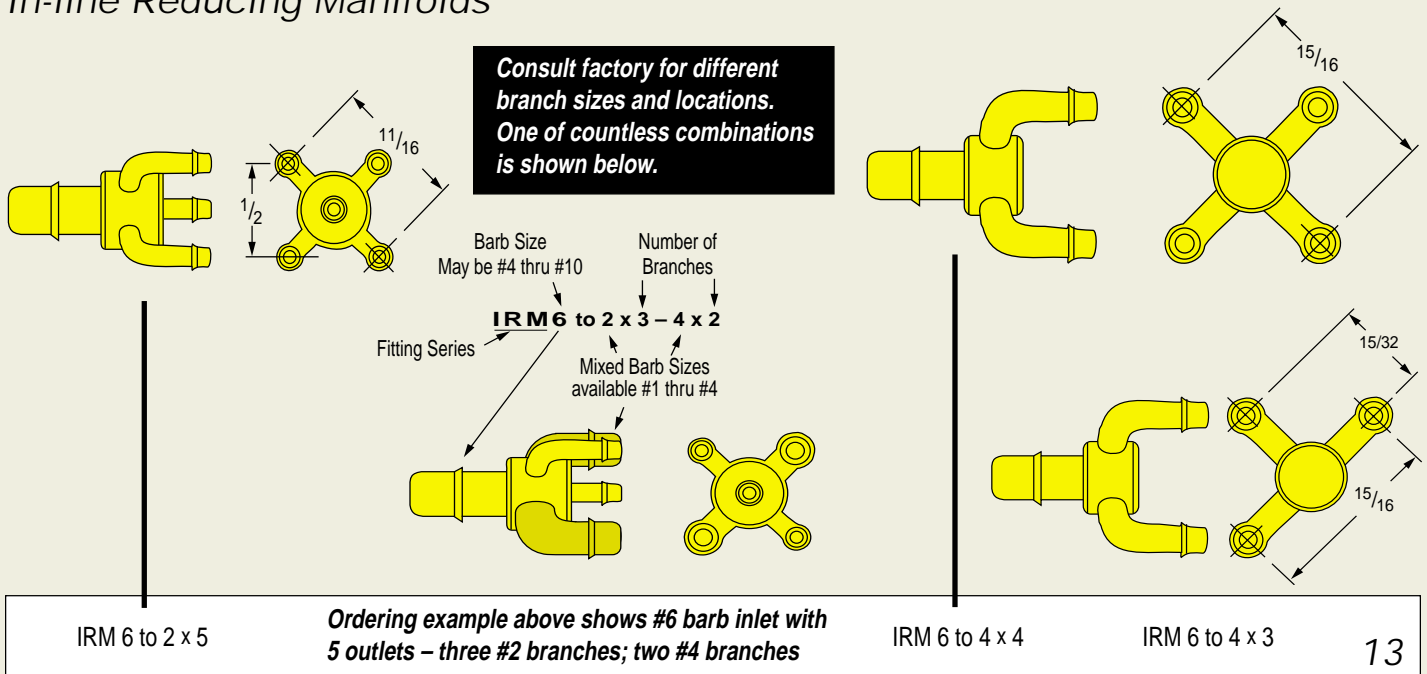

“Y” Fittings

Note: Other “Y” sizes are available as reducing “Ys”

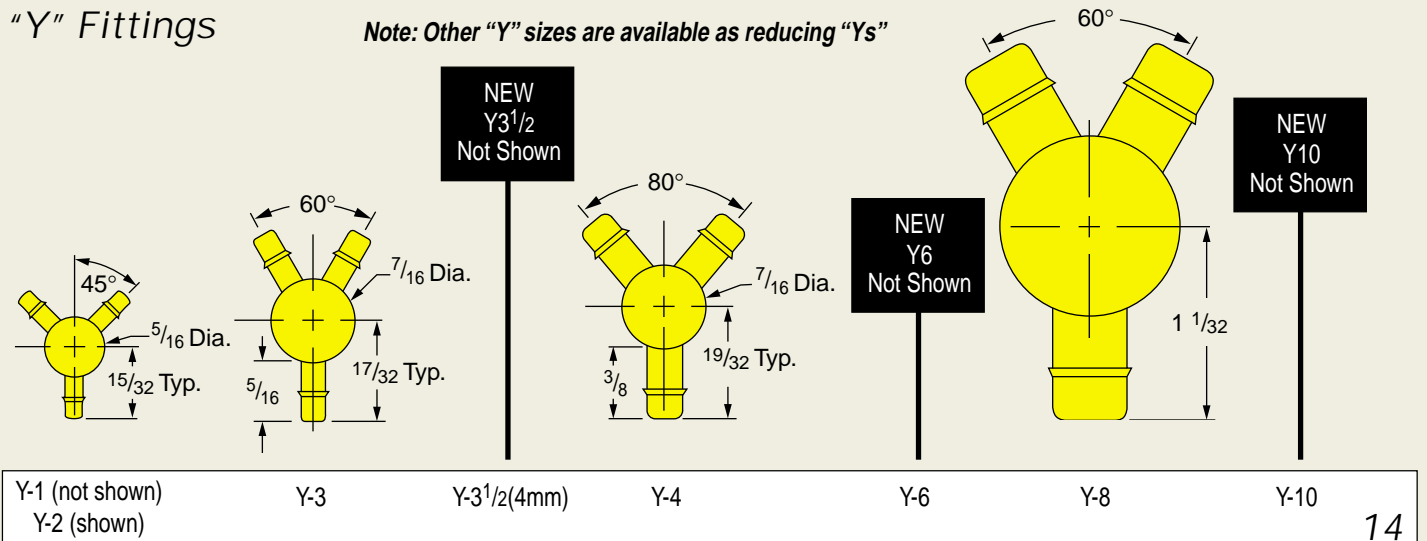

10-32 Male Thread to Tube with O-Ring Seal Assembled (Also available as orifice fittings)

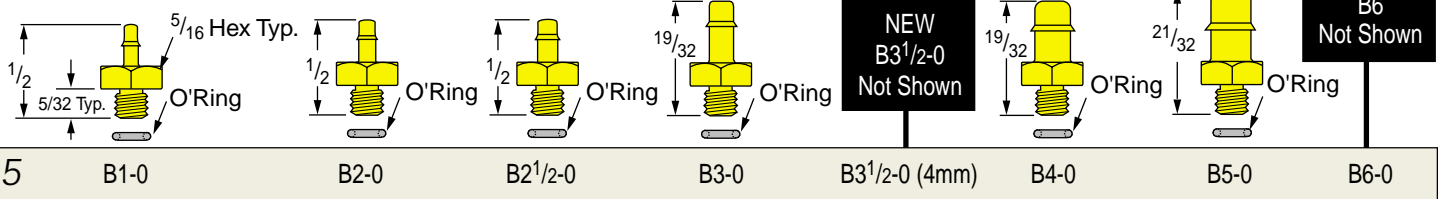

10-32 Male Thread to Tube with Captive Rubber Gasket Assembled

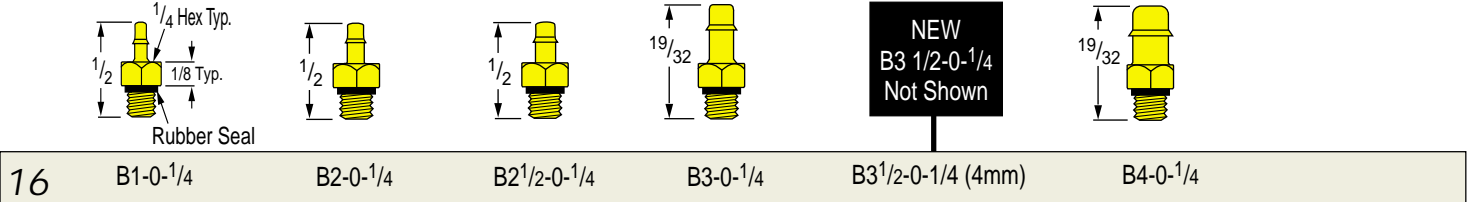

10-32 Male Thread to Tube Fibre Gasket Supplied

(*Also available with 3-56, 6-32 and 8-32 Threads – see page 30)

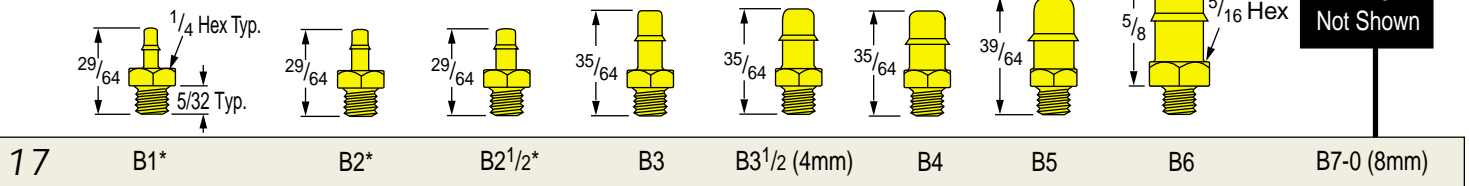

Elbows: 10-32 Male to Tube Fibre Gasket Supplied

†Note: also available with captive rubber seal

*Note: also available with "O" Ring seal

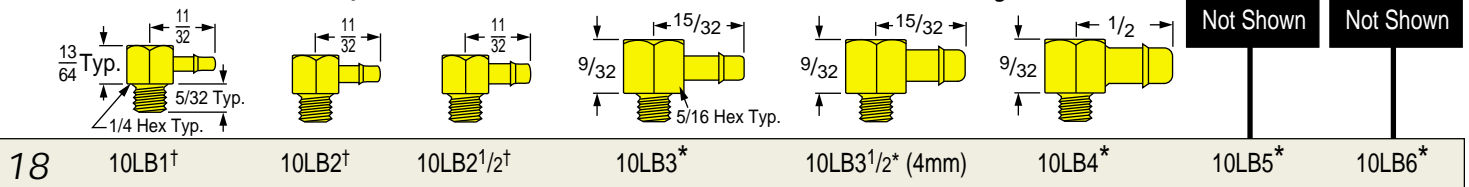

Tees: 10-32 Male to Tube Fibre Gasket Supplied

†Note: also available with captive rubber seal

*Note: also available with "O" Ring seal

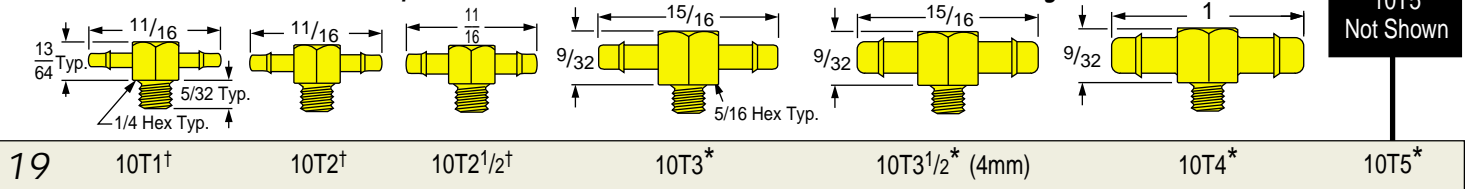

10-32 Caps, Plugs & Extensions

See more 10-32 fittings on pages 25 & 26

(†Note: Fibre Gasket Supplied)

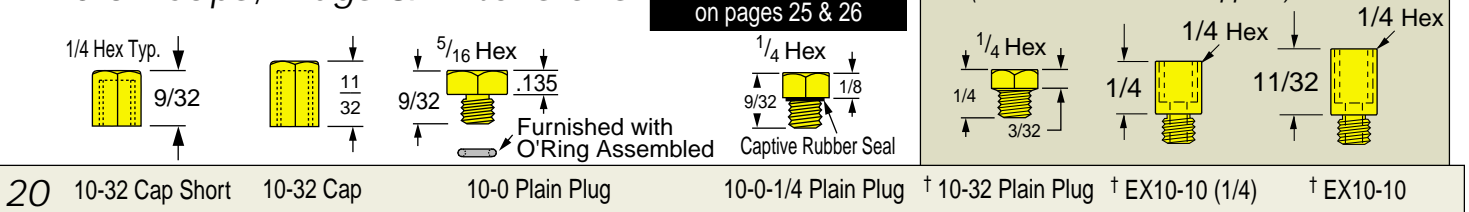

10-32 Female Thread to Tube

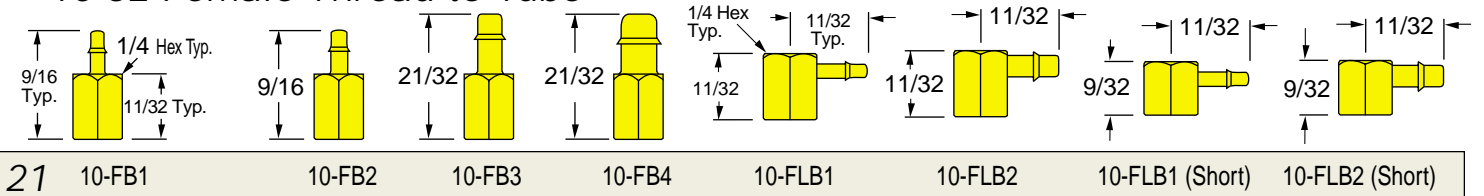

10-32 Adjustable Elbows with O-Ring Seals Assembled

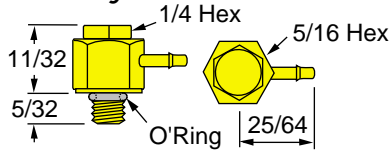

A10-LB1

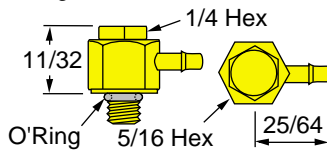

A10-LB 2

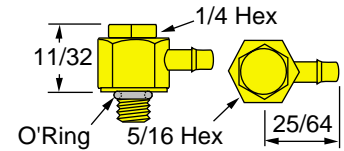

A10-LB 2 1/2

22

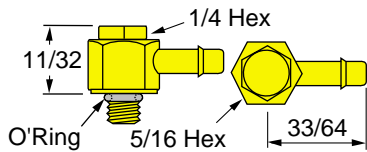

A10-LB3

NEW
A10-LB3 1/2
Not Shown

A10-LB3 1/2 (4mm)

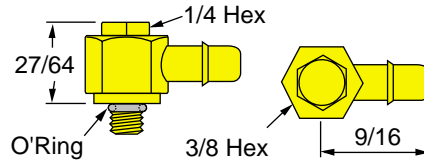

A10-LB4

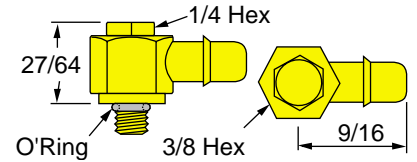

A10-LB 5

23

10-32 Adjustable TEES with O-Ring Seals Assembled

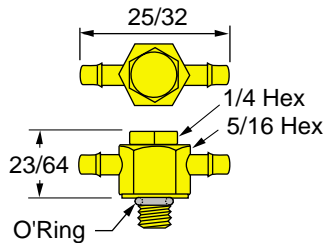

A10-T2 1/2

NEW
A10-T3 1/2
Not Shown

A10-T3 1/2 (4mm)

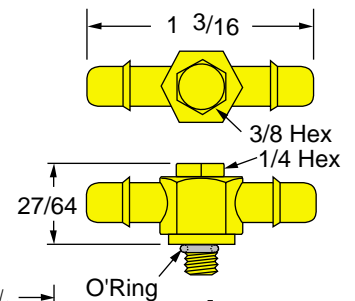

A10-T5

24

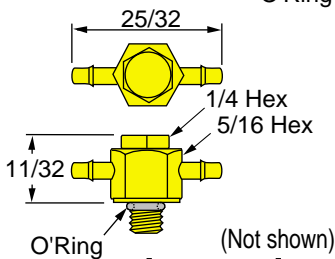

A10-T1

(Not shown)

A10-T2

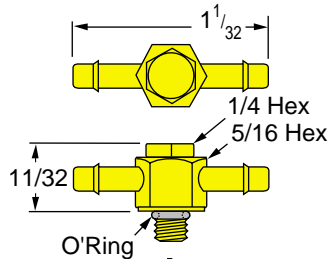

A10-T3

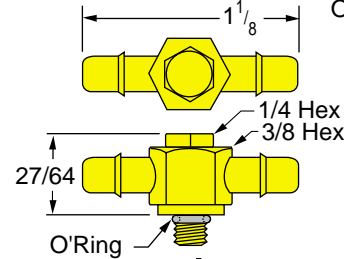

A10-T4

10-32 Swivel Elbows Fibre Gasket Supplied

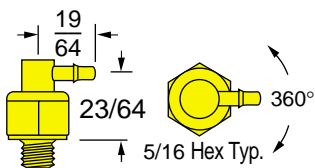

10SW-L1

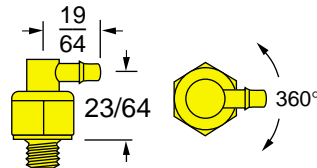

10SW-L2

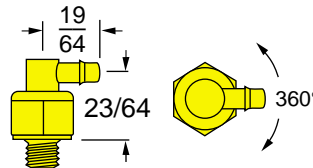

10SW-L2 1/2

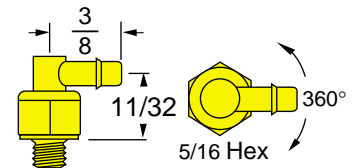

10SW-L3

25

10-32 Swivel Tees Fibre Gasket Supplied

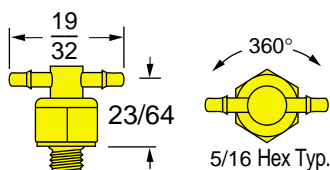

10SW-T1

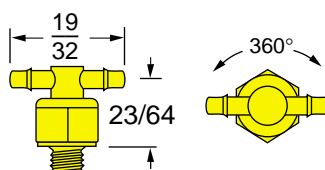

10SW-T2

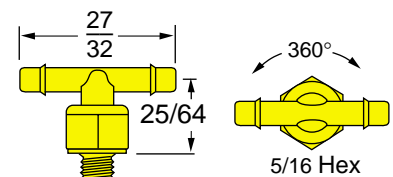

10SW-T3

26

1/4-28 Male Straight Thread to Tube Fibre Gasket Supplied

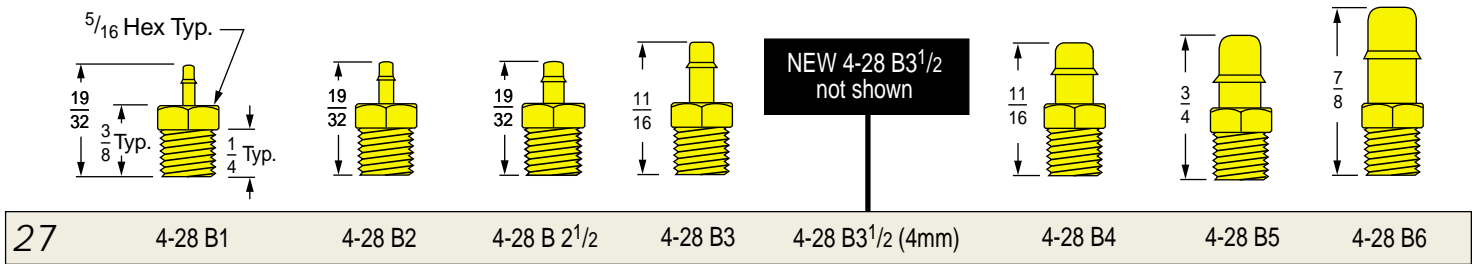

Elbows: 1/4-28 Male to Tube Fibre Gasket Supplied

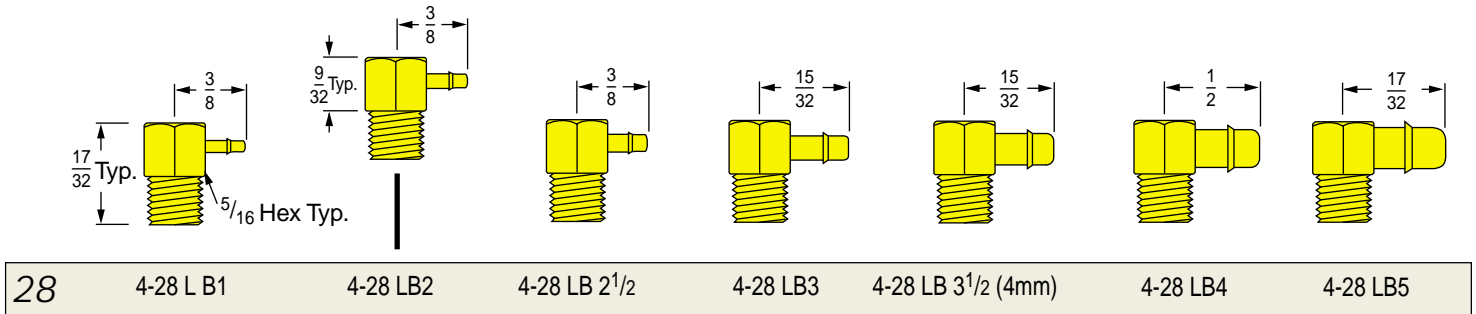

L-Tees: 1/4-28 Male to Tube Fibre Gasket Supplied

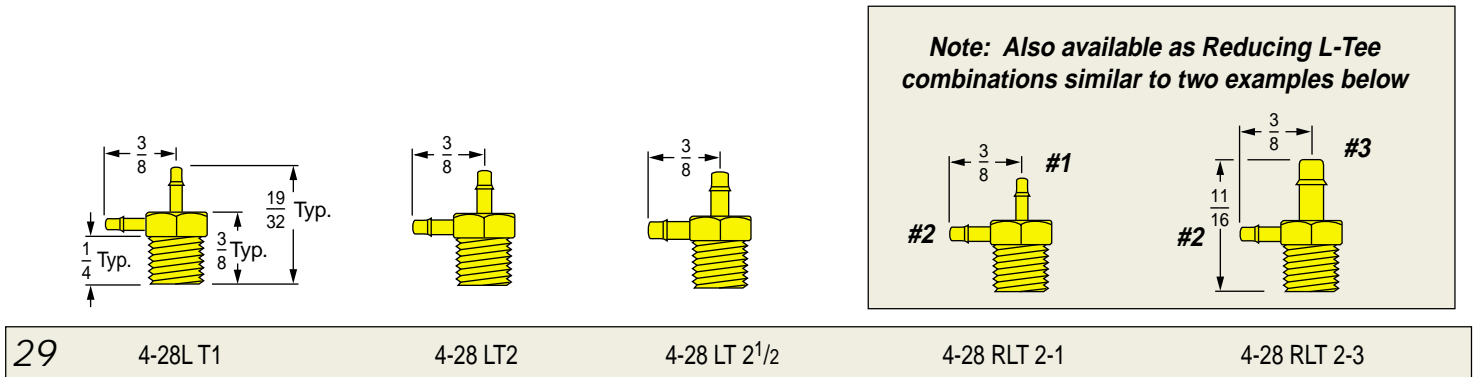

Tees: 1/4-28 Male to Tube Fibre Gasket Supplied

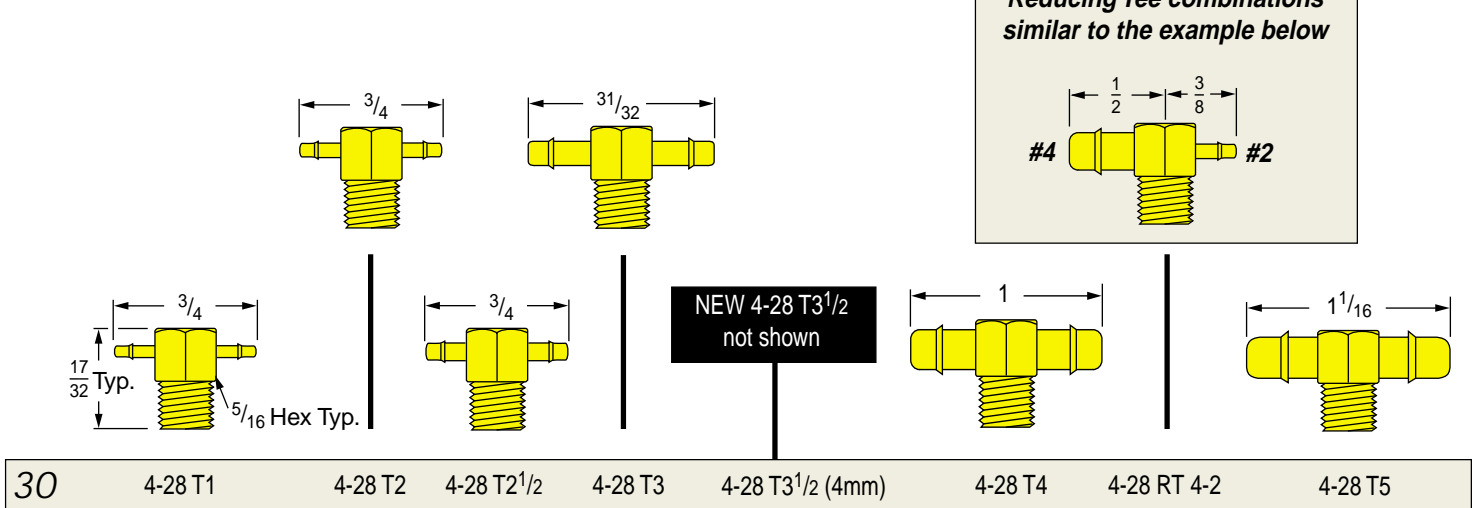

1/16 Male Pipe Thread to Tube

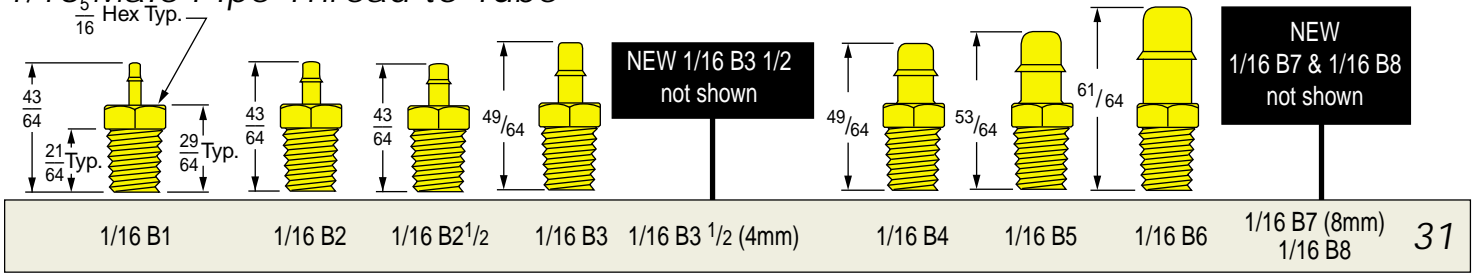

Elbows: 1/16 NPT Male to Tube

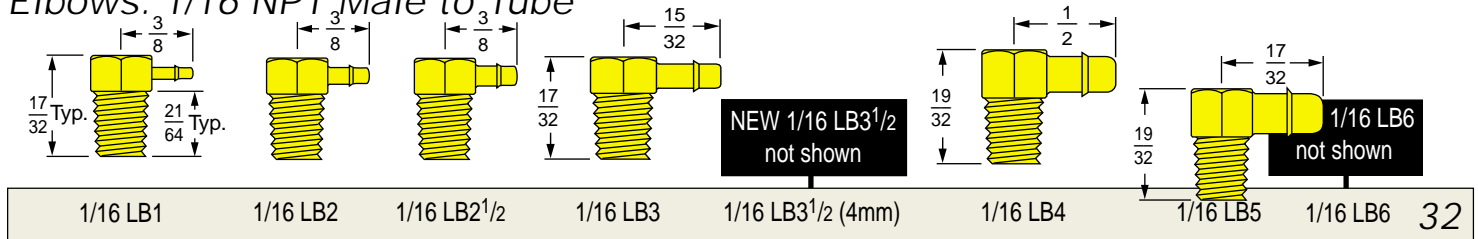

L-Tees: 1/16 NPT Male to Tube

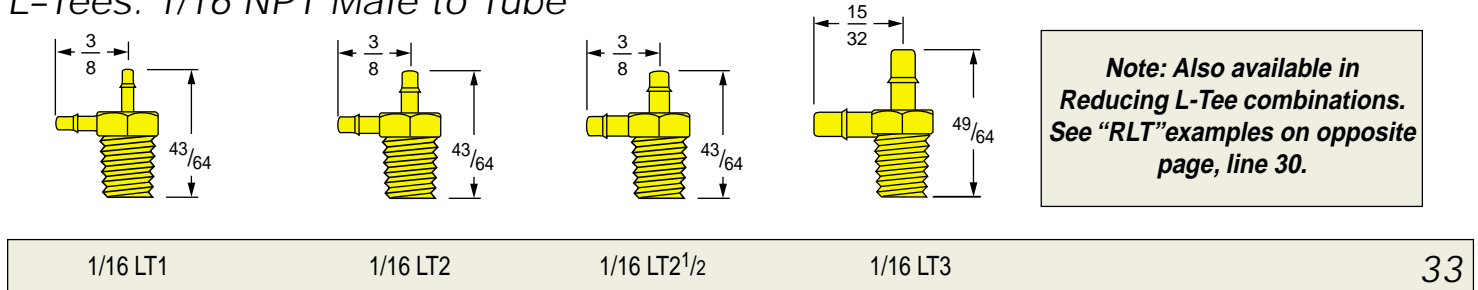

45° Elbows - NEW

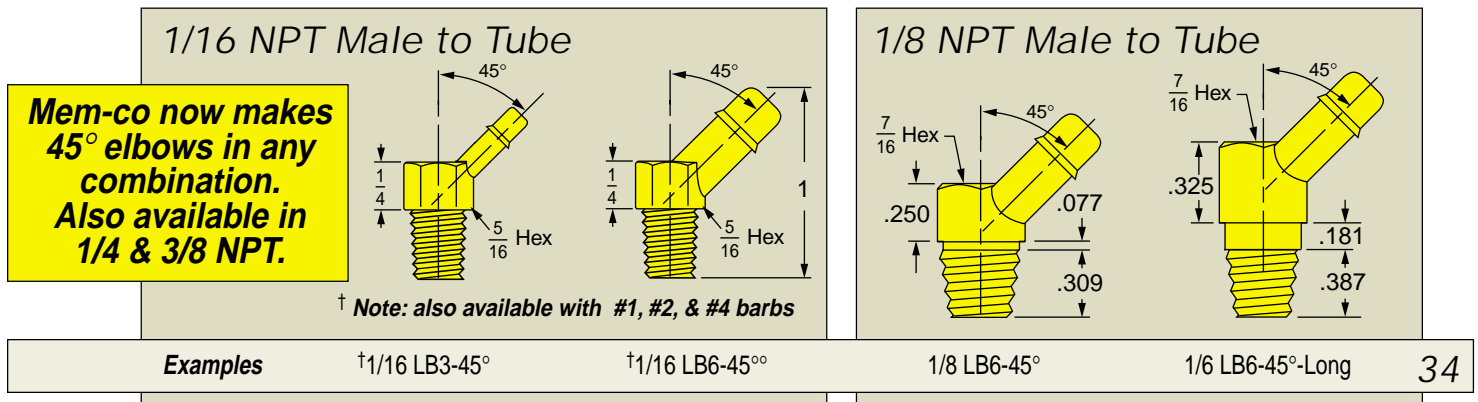

Tees: 1/16 NPT Male to Tube

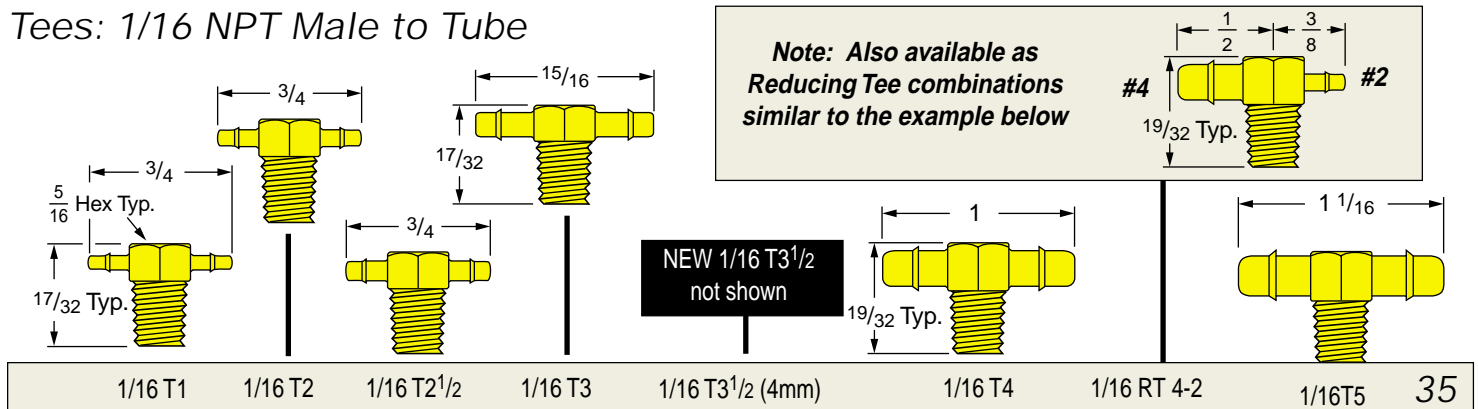

1/8 Male Pipe Thread to Tube

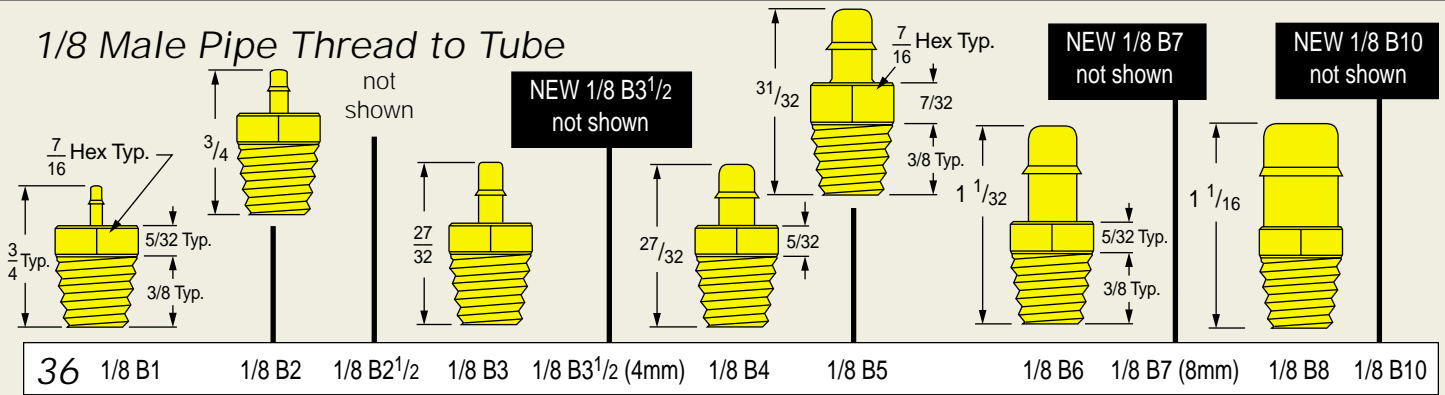

1/8 Male Pipe Straight Manifolds

Part Numbering Example

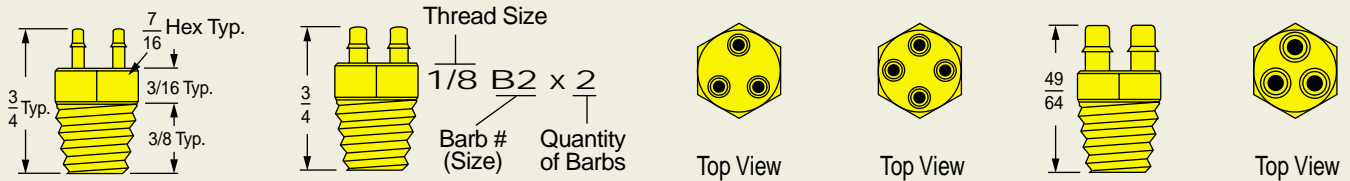

Elbows: 1/8 NPT to Tube

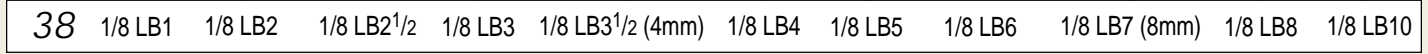
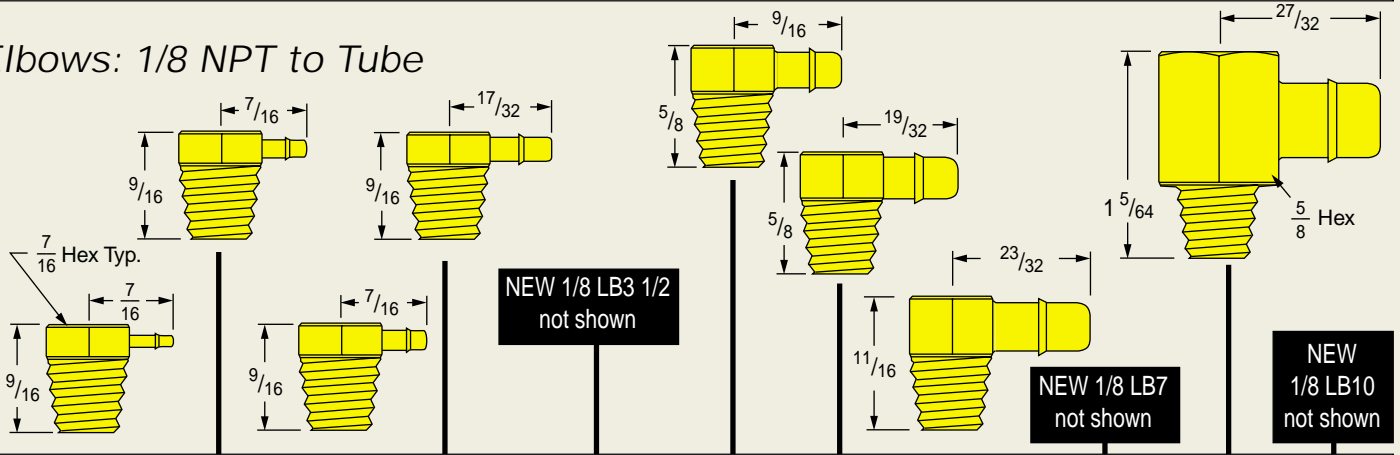

L-Tees: 1/8 NPT Male to Tube

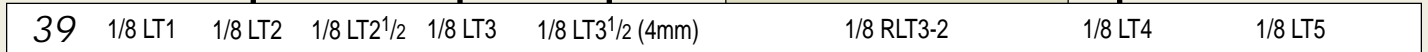
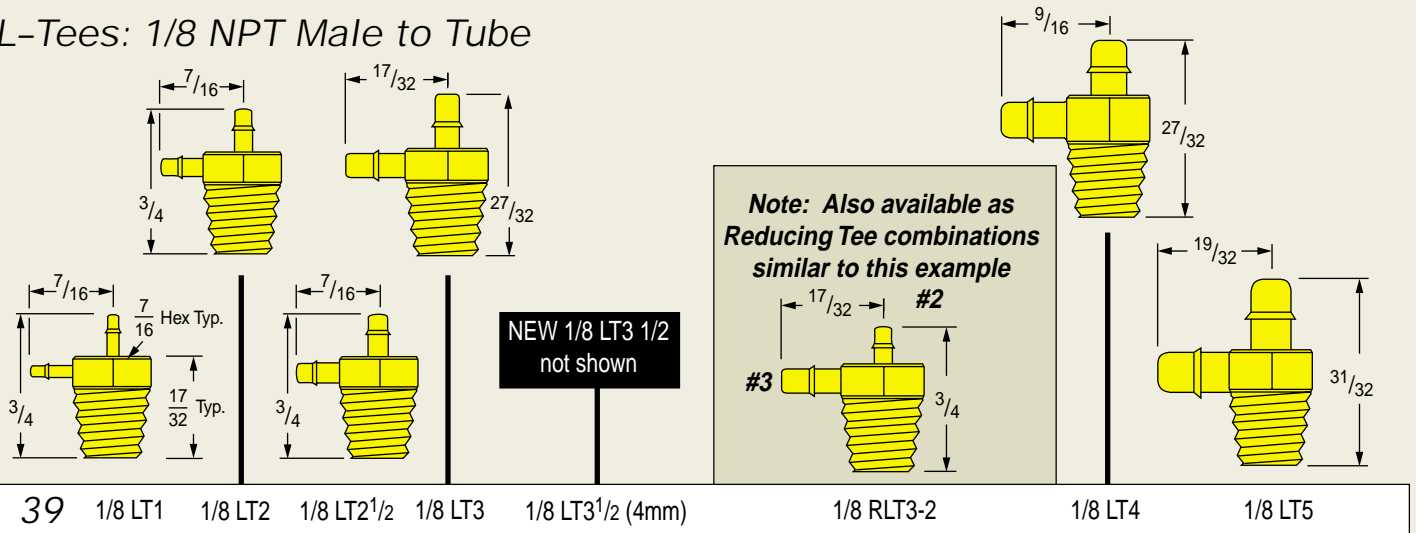

Tees: 1/8 NPT Male to Tube

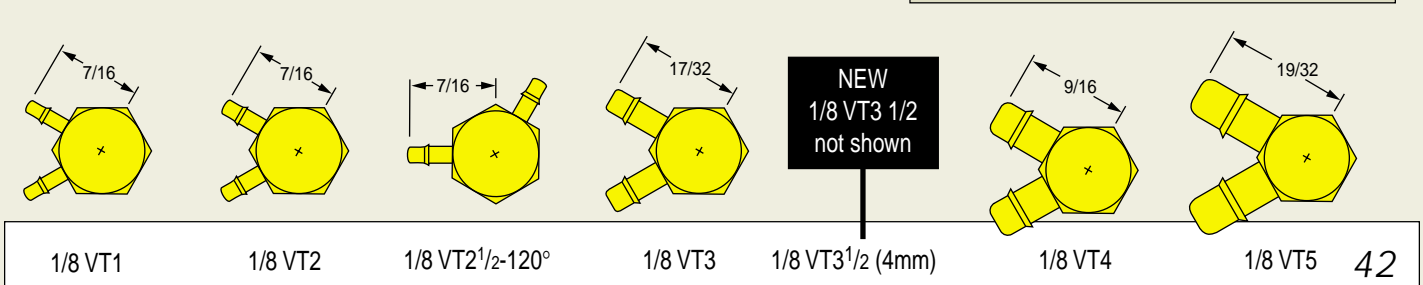
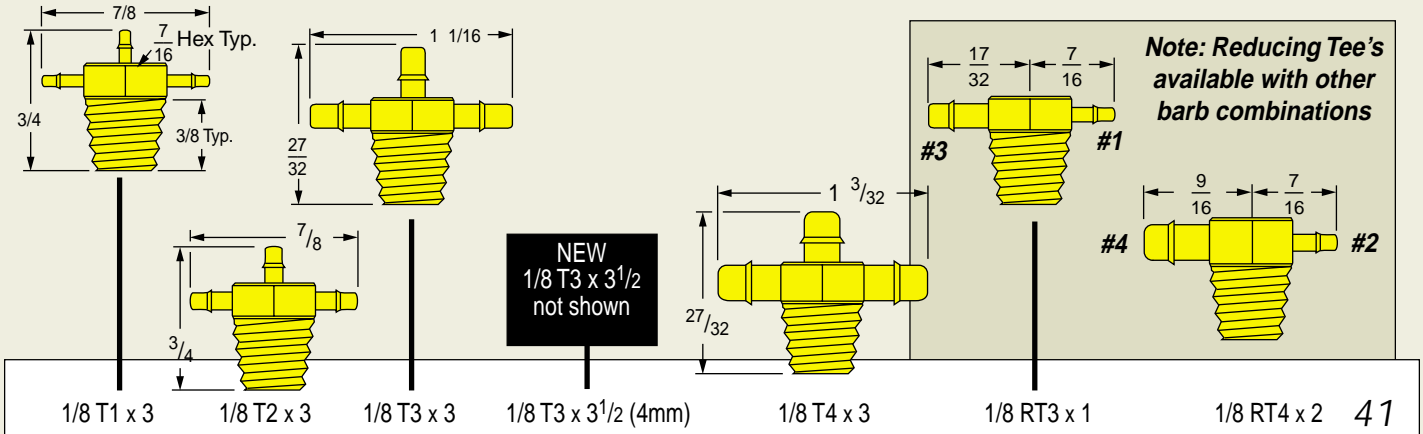
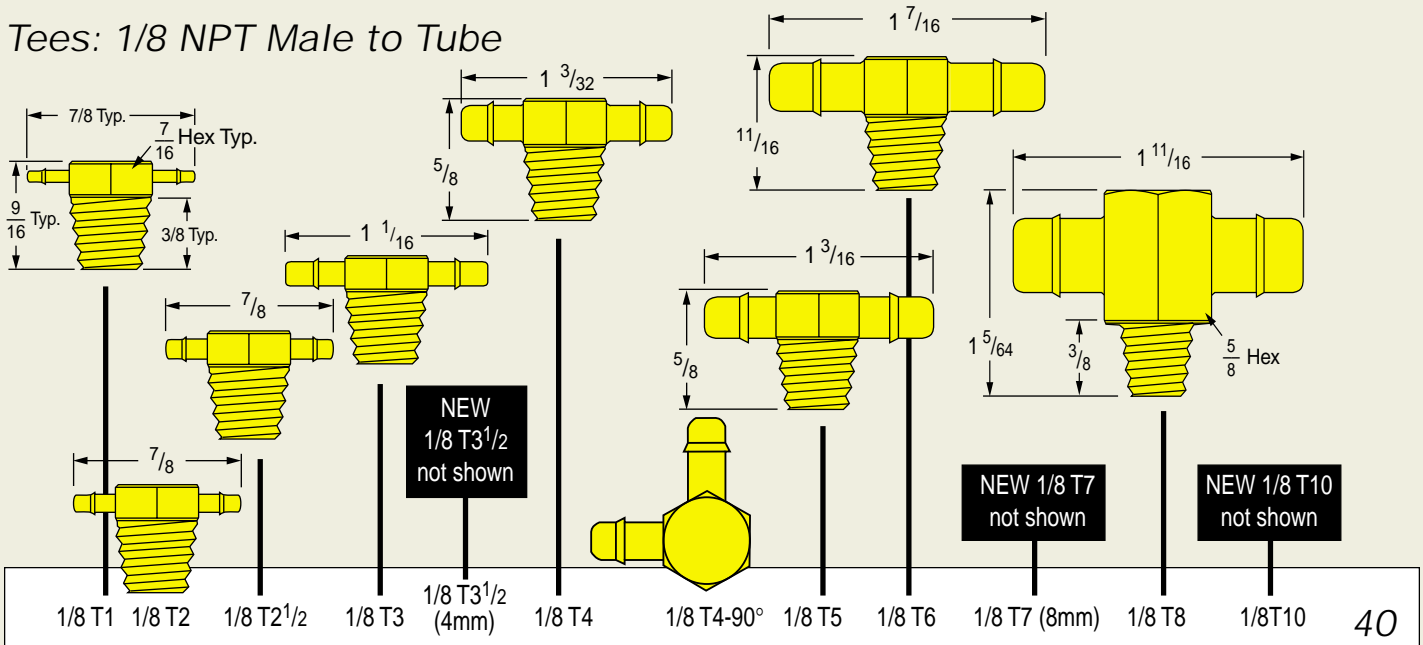

1/8 Male Pipe Nipples with Tube Branches

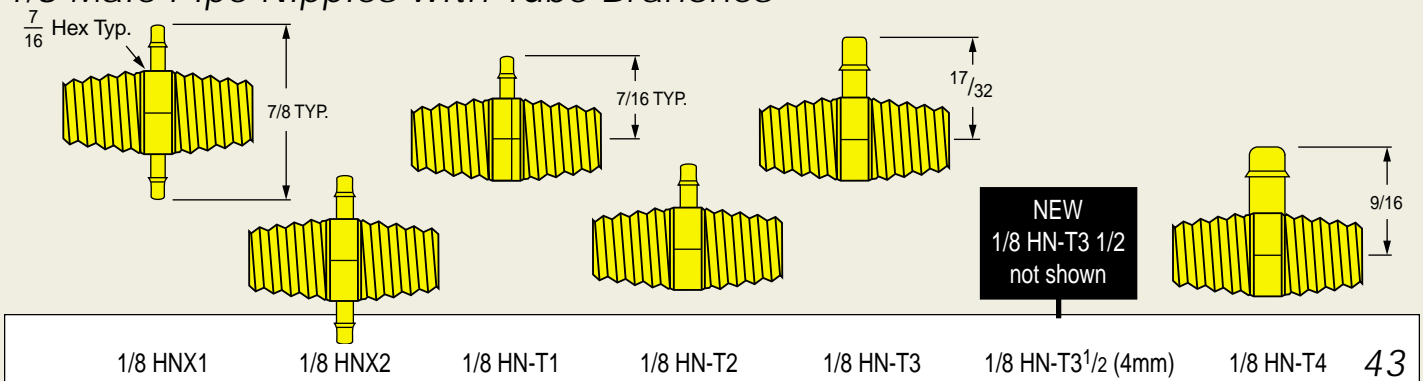

1/4 Male Pipe Thread to Tube

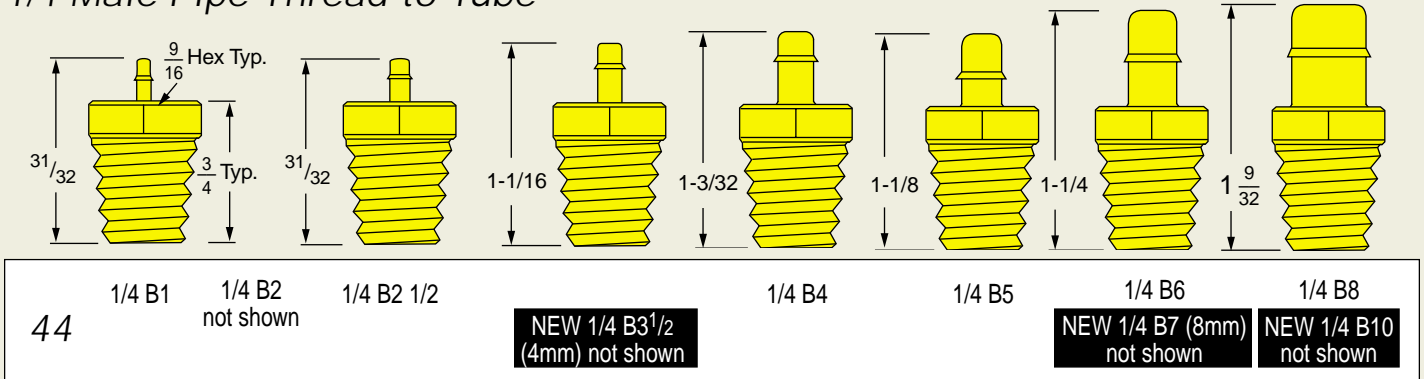

1/4 Male Pipe Straight Manifolds

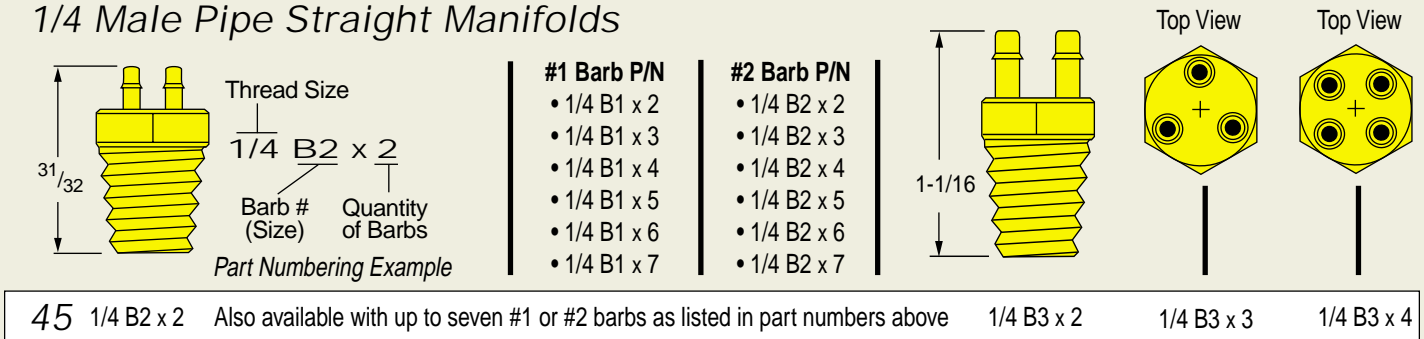

Elbows: 1/4 NPT Male to Tube

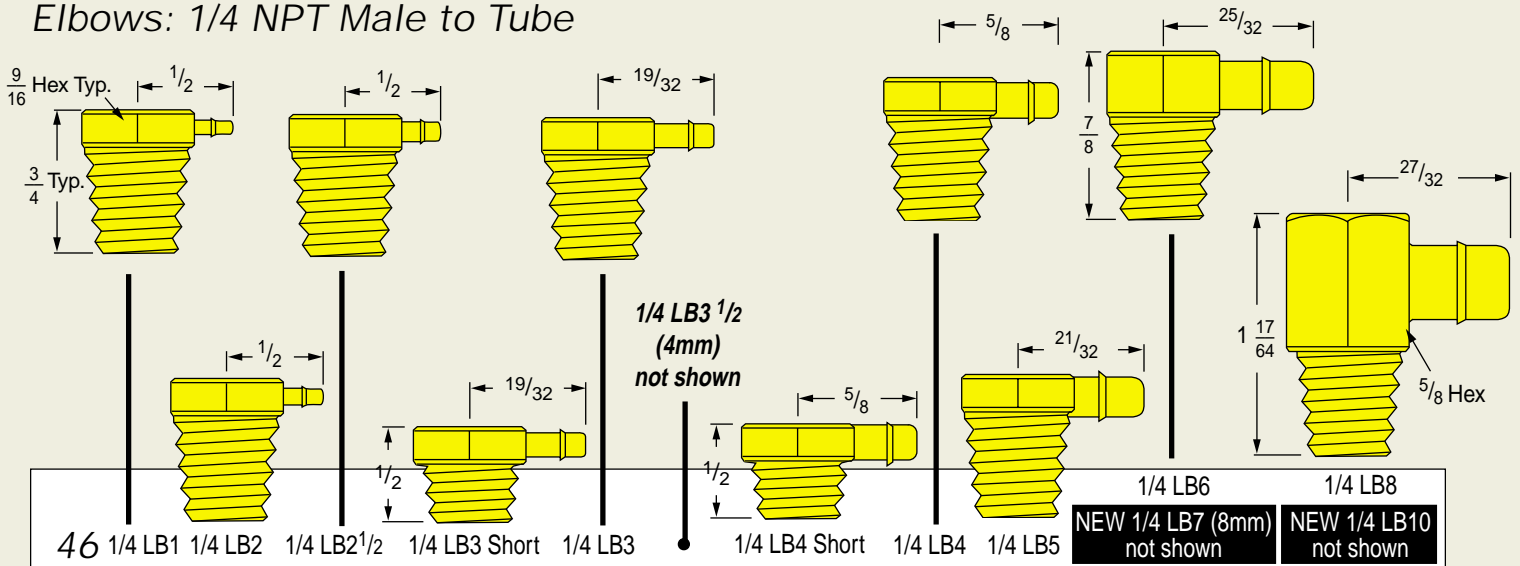

L-Tees: 1/4 NPT Male to Tube

Note: Available in Reducing L-Tee combinations similar to the example below

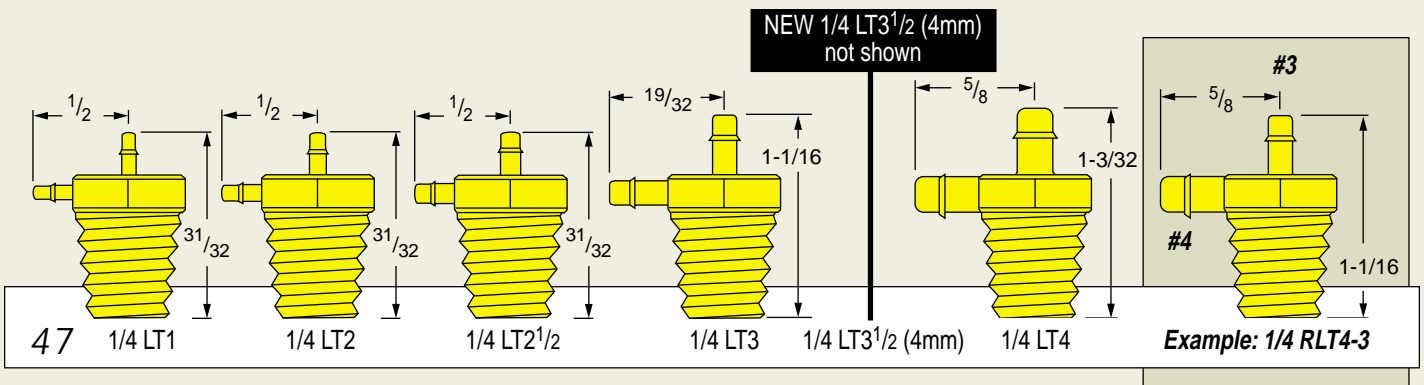

Tees: 1/4 NPT Male to Tube

Note: Also available as Reducing Tee combinations similar to this example of part number 1/4 RT4-2

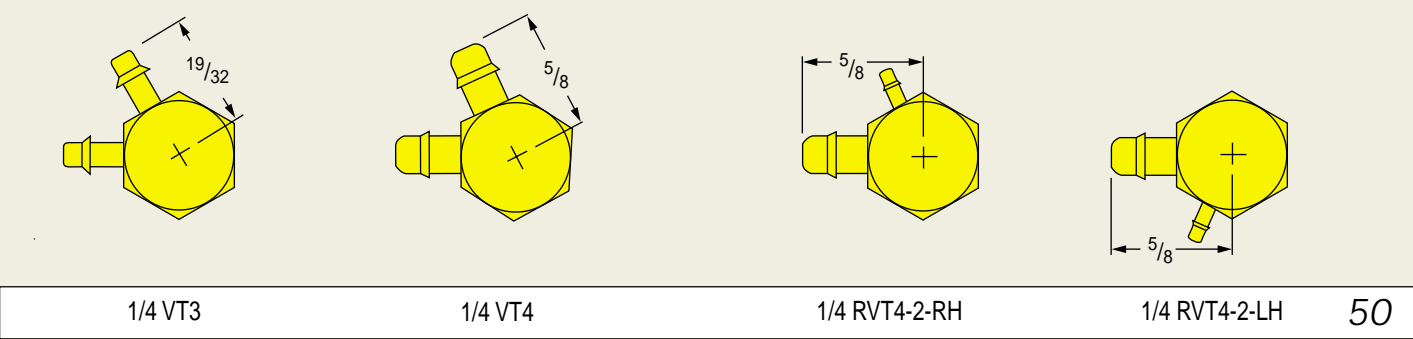
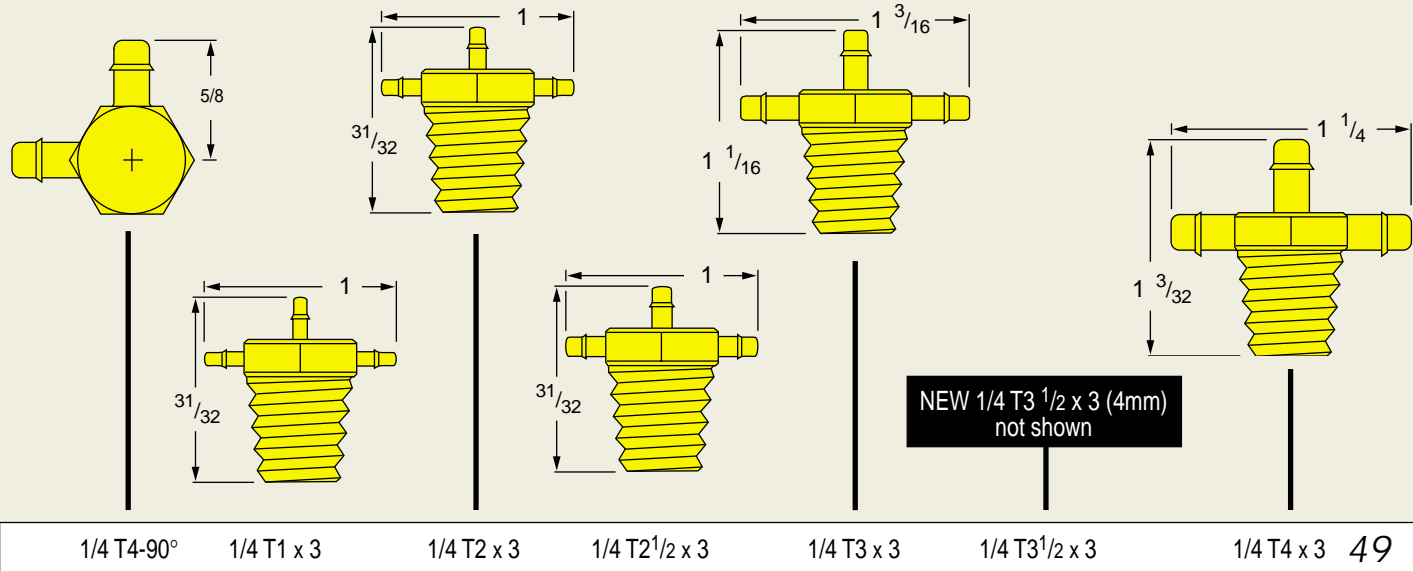
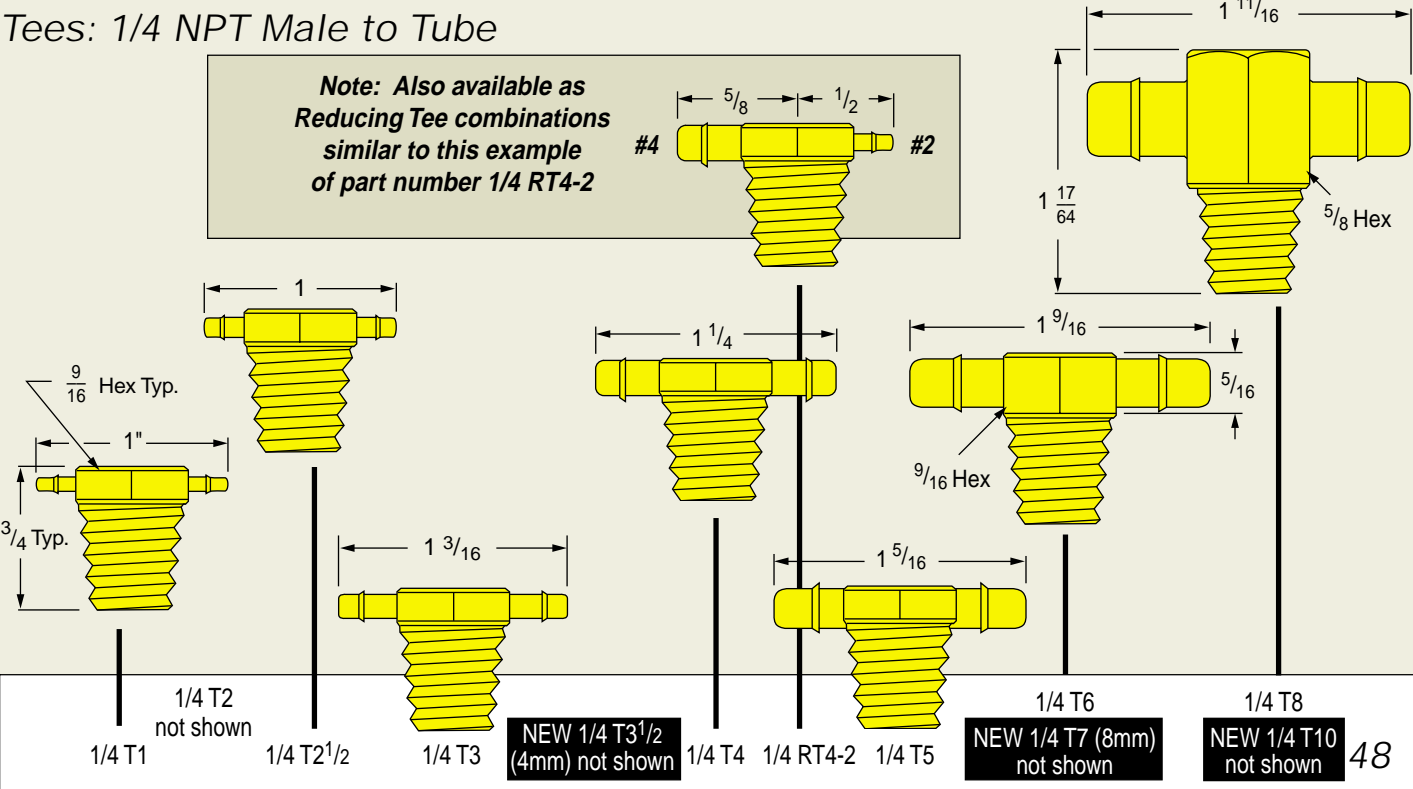

3/8 Male Pipe Thread to Tube

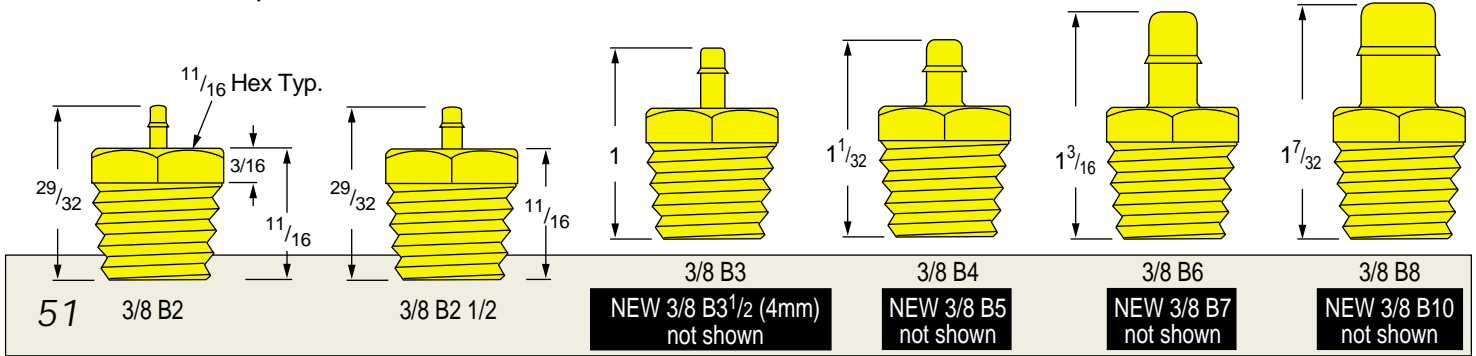

3/8 Male Pipe Straight Manifolds

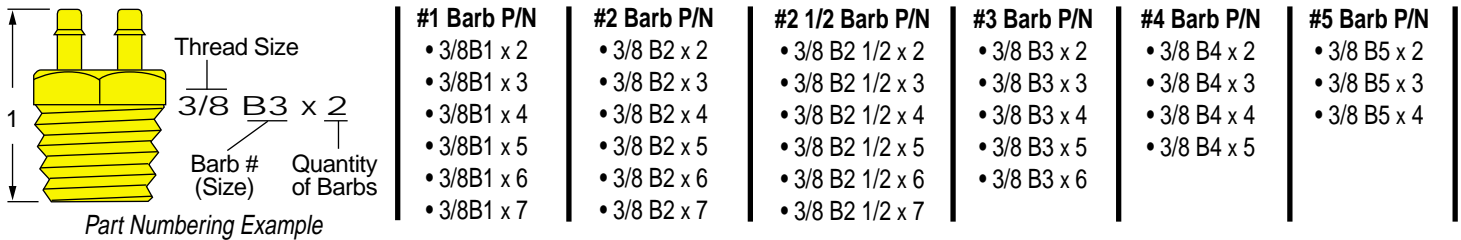

52 Available with #1, #2, #2 1/2, #3, #4, and #5 barbs as listed in the part numbers above

Elbows: 3/8 NPT Male to Tube

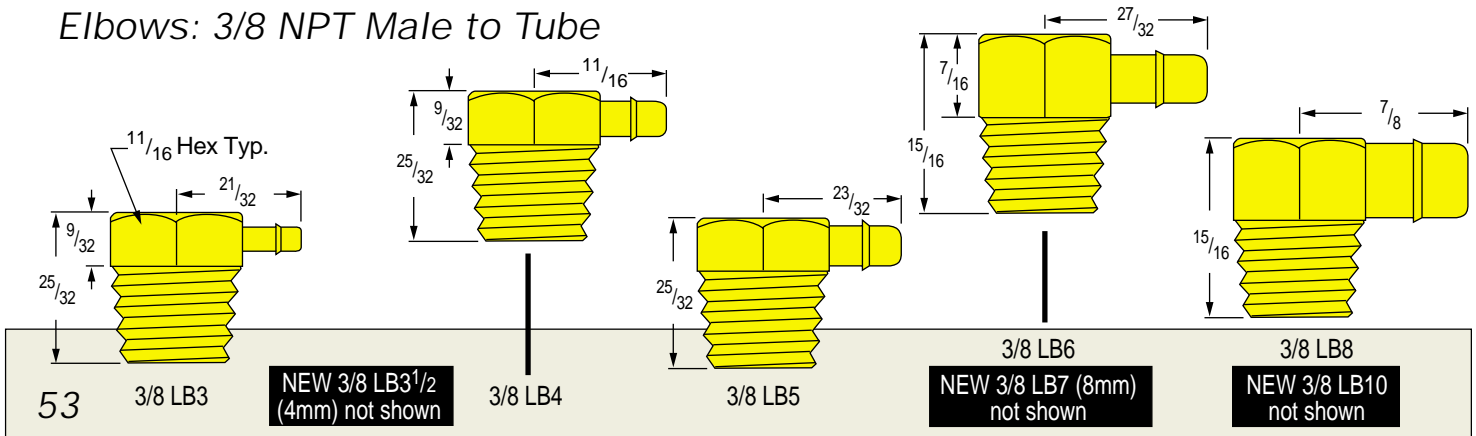

Tees: 3/8 NPT Male to Tube

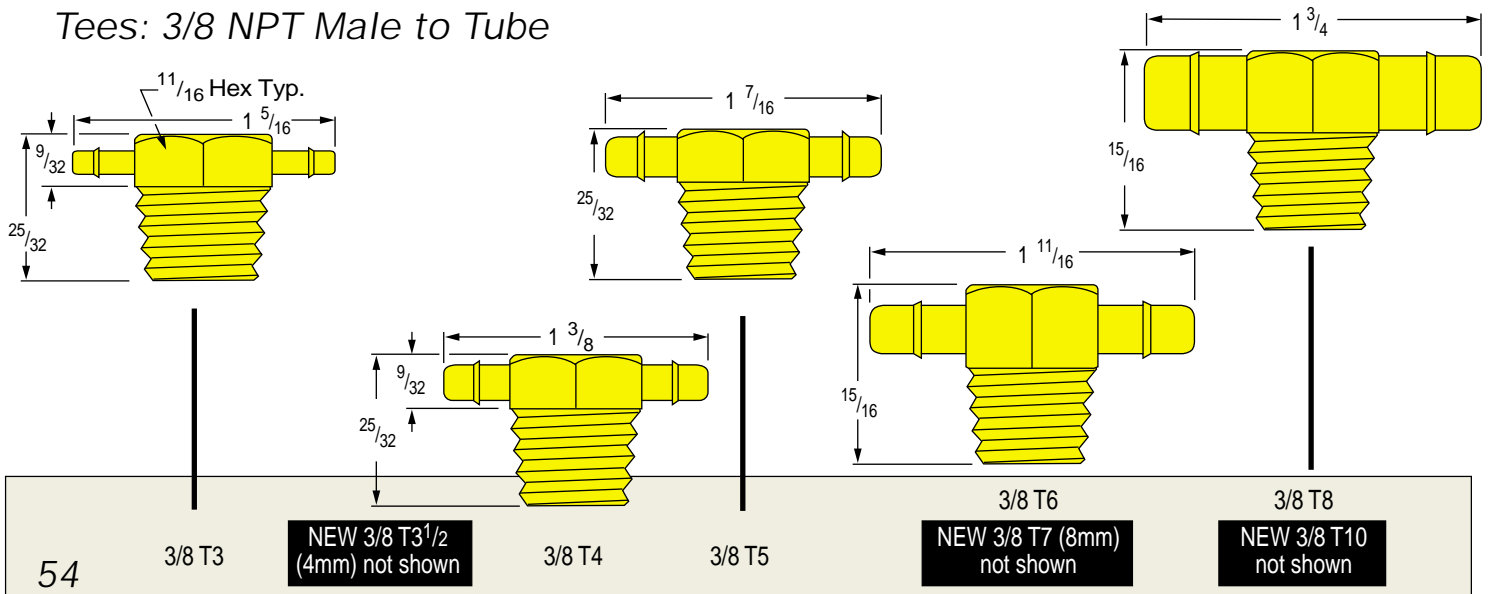

1/8 Female Pipe Thread to Tube

Top Views of Manifold Fittings
(Available with #1 or #2 Barbs)

NEW
1/8 FB3 1/2 x 3
not shown

9/16 Hex Typ.
23/32
1/2 Typ.

23/32
1/2

23/32
1/2

Thread Size, Female
1/8F B2 x 2

Barb # Quantity of Barbs

Part Numbering Example

1/8 FB1	1/8 FB2	1/8 FB1 x 2 1/8 FB2 x 2	1/8 FB1 x 3 1/8 FB2 x 3	1/8 FB1 x 4 1/8 FB2 x 4	1/8 FB1 x 5 1/8 FB2 x 5	1/8 FB1 x 6 1/8 FB2 x 6	1/8 FB1 x 7 1/8 FB2 x 7	1/8 FB3 1/2 x 3 (4mm)	55
---------	---------	----------------------------	----------------------------	----------------------------	----------------------------	----------------------------	----------------------------	-----------------------	----

1/8 FB3 1/2 x 3
not shown

7/8

27/32

13/16
1/2

13/16
1/2

13/16
1/2

1
1 1/32

1/8 FB2 1/2	1/8 FB3	1/8 FB3 x 2	1/8 FB3 x 3	1/8 FB3 1/2 (4mm)	1/8 FB4	1/8 FB5	1/8 FB6	1/8 FB8	56
-------------	---------	-------------	-------------	-------------------	---------	---------	---------	---------	----

Elbows: 1/8 NPT Female to Tube

9/16 Hex Typ.
1/2
1/2 Typ.

1/2

19/32

21/32

45°

9/16 Hex

1/2

29/32

1/2

19/32

5/8

25/32

9/16

1/8 FLB1	1/8 FLB2	1/8 FLB2 1/2	1/8 FLB3	1/8 FLB3 1/2	1/8 FLB4	1/8 FLB5	1/8 FLB6	1/8 FLB6-45°	57
----------	----------	--------------	----------	--------------	----------	----------	----------	--------------	----

L-Tees: 1/8 NPT Female to Tube

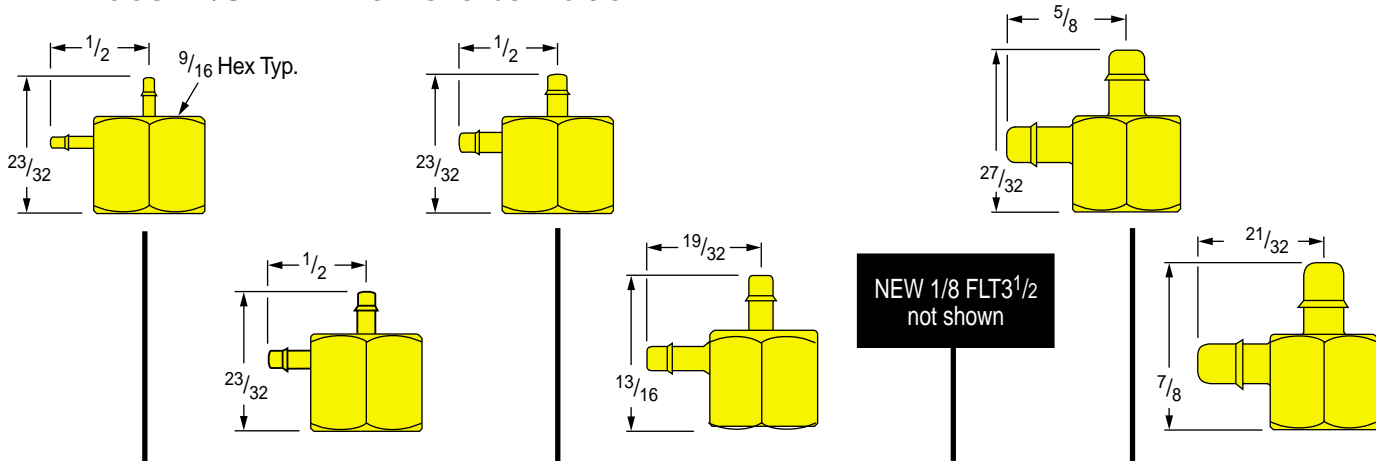

58 1/8 FLT1 1/8 FLT2 1/8 FLT2 1/2 1/8 FLT3 1/8 FLT3 1/2 (4mm) 1/8 FLT4 1/8 FLT5

V-Tees: 1/8 NPT Female to Tube

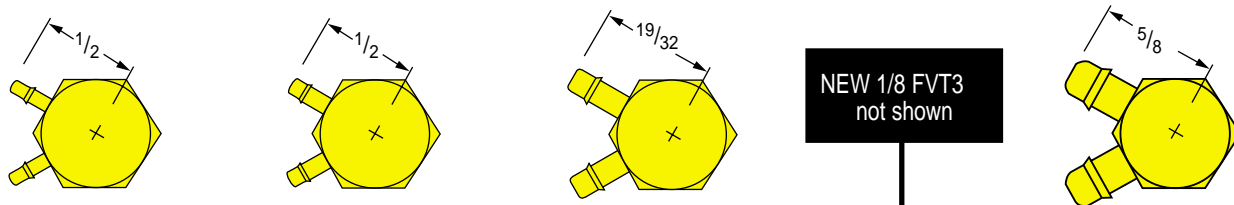

59 1/8 FVT1 1/8 FVT2 1/8 FVT3 1/8 FVT3 1/2 (4mm) 1/8 FVT4

Tees: 1/8 NPT Female to Tube

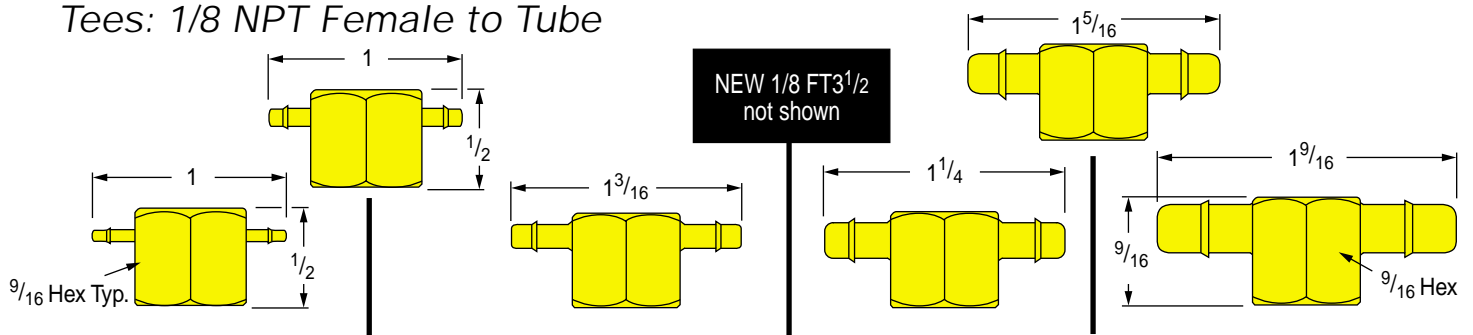

60 1/8 FT1 1/8 FT2 1/8 FT3 1/8 FT3 1/2 (4mm) 1/8 FT4 1/8 FT5 1/8 FT6

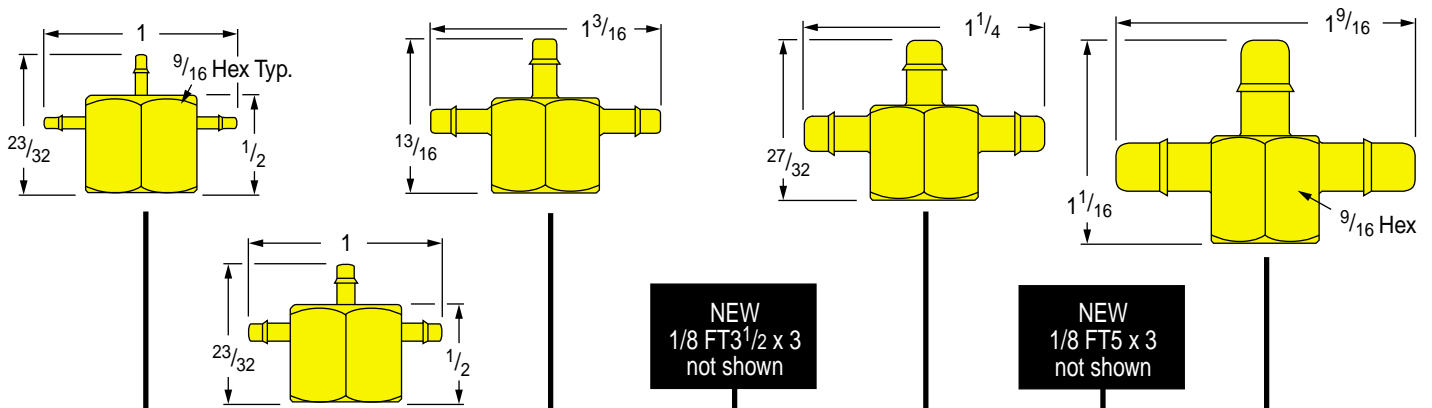

61 1/8 FT1 x 3 1/8 FT2 x 3 1/8 FT3 x 3 1/8 FT3 1/2 x 3 (4mm) 1/8 FT4 x 3 1/8 FT5 x 3 1/8 FT6 x 3

1/4 Female Pipe Thread to Tube

Manifold Fittings Top Views
(Available with up to eight #1 or #2 Barbs)

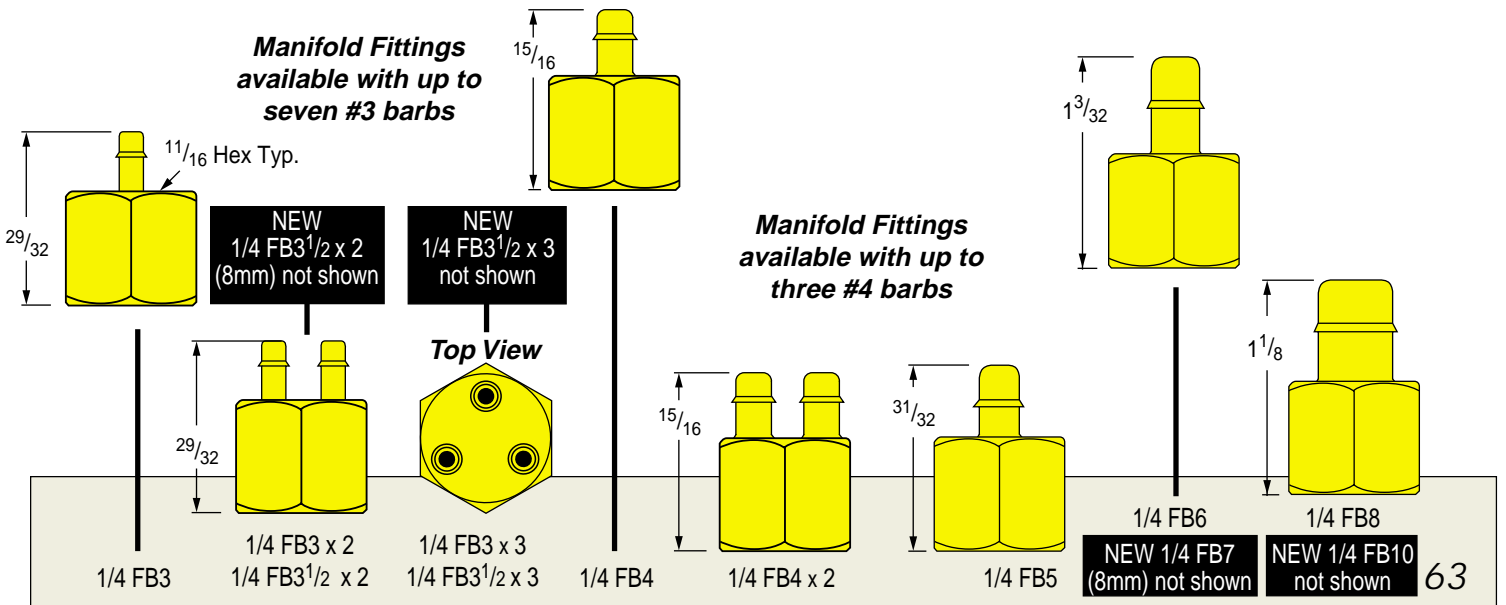
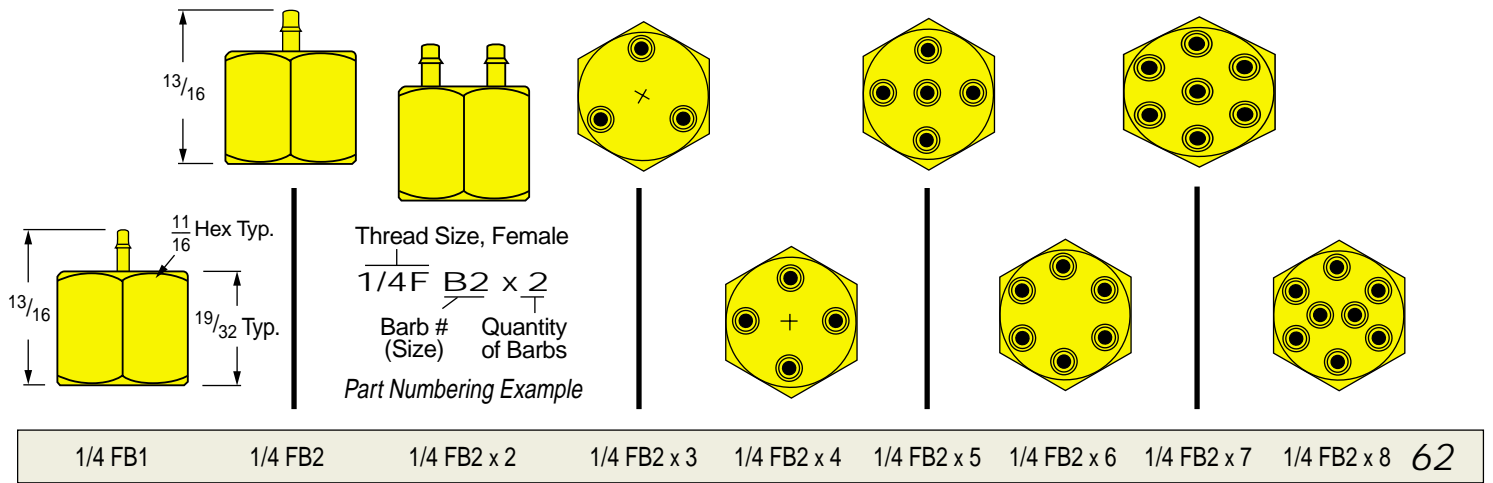

Elbows: 1/4 NPT Female to Tube

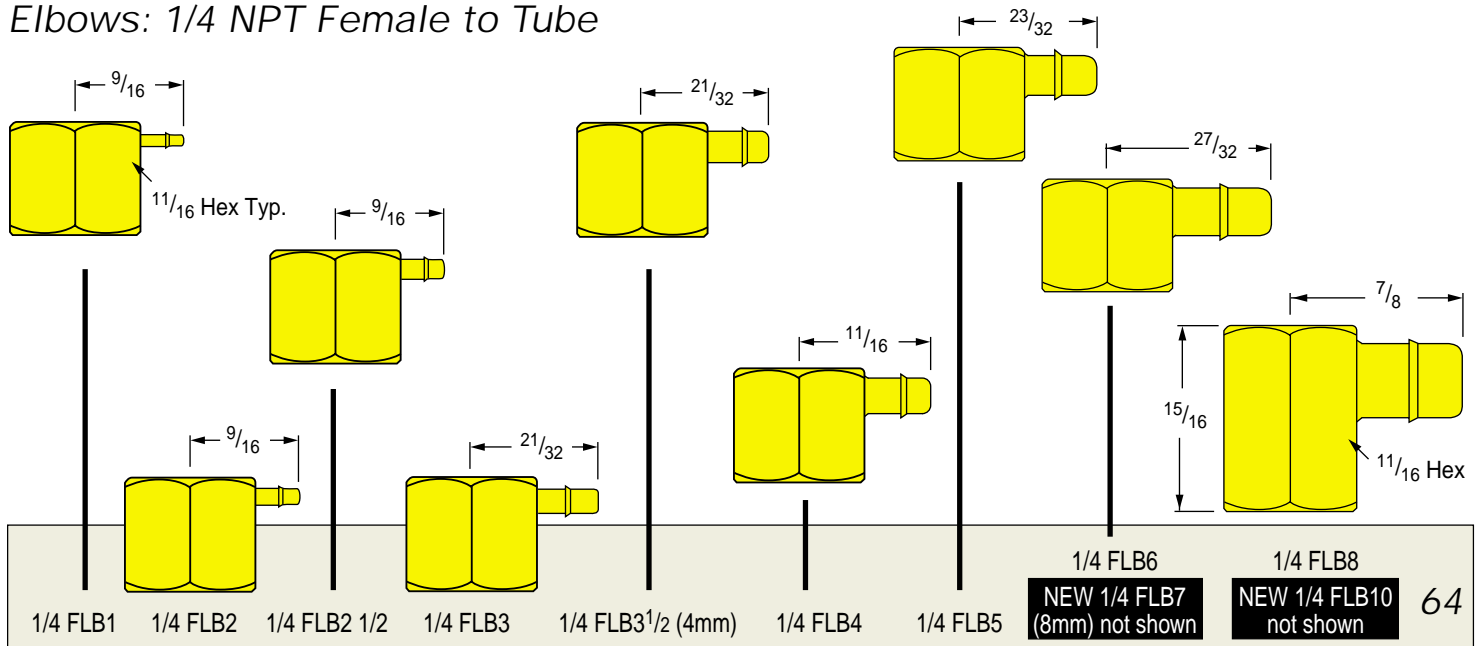

L-Tees: 1/4 NPT Female to Tube

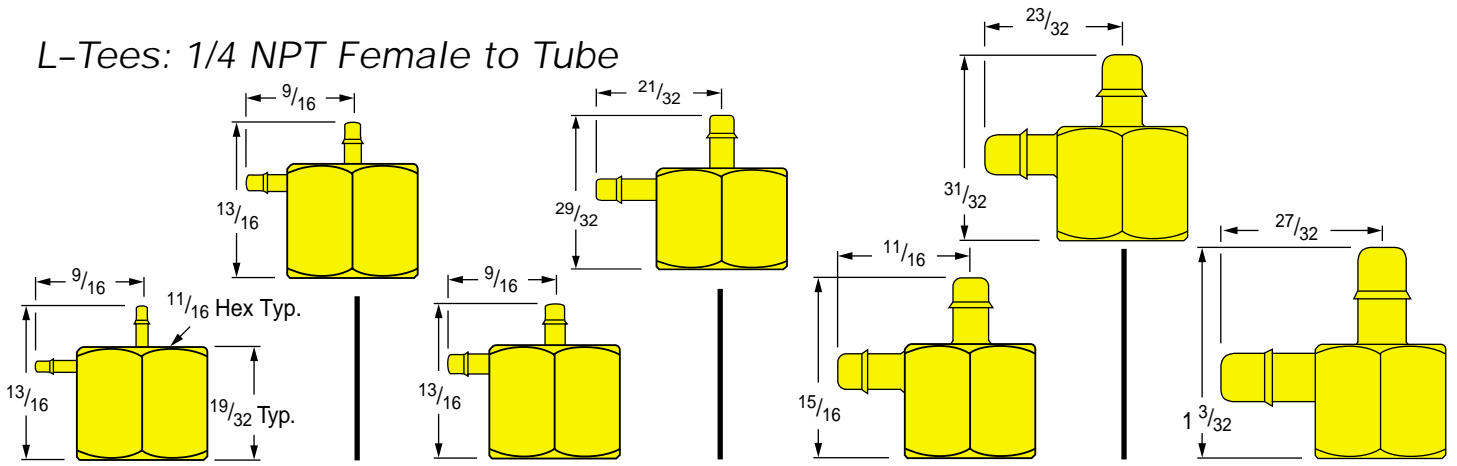

65 1/4 FLT1 1/4 FLT2 1/4 FLT2 1/2 1/4 FLT3 1/4 FLT4 1/4 FLT5 1/4 FLT6

Tees: 1/4 NPT Female to Tube

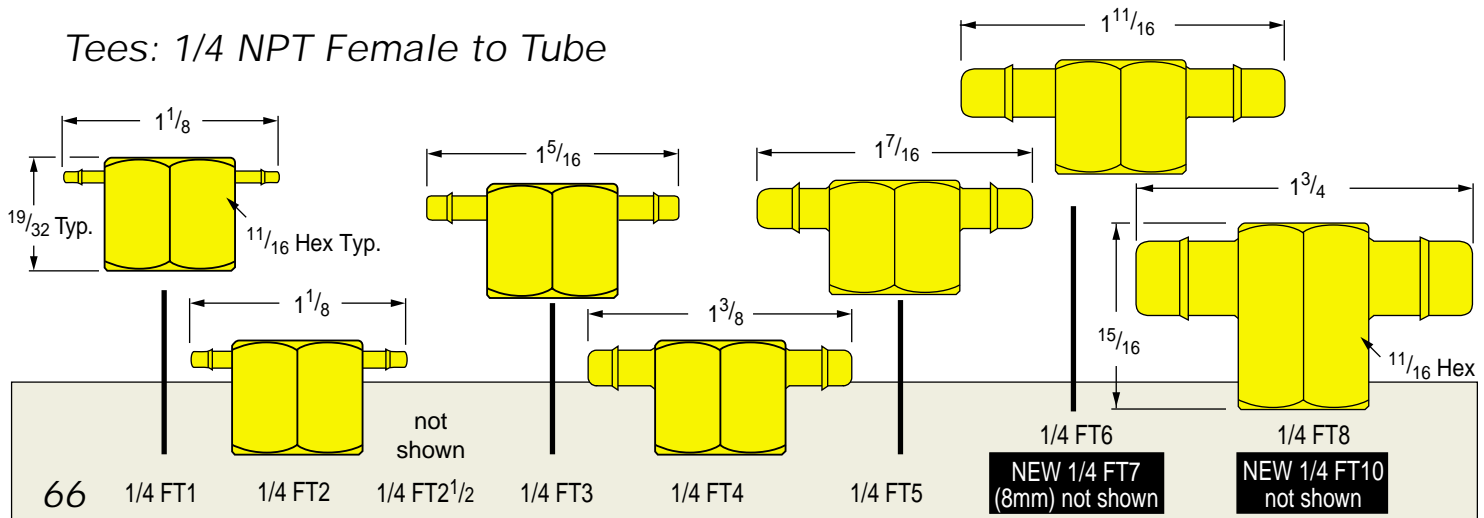

66 1/4 FT1 1/4 FT2 1/4 FT2 1/2 1/4 FT3 1/4 FT4 1/4 FT5 1/4 FT6 NEW 1/4 FT7 (8mm) not shown 1/4 FT8 NEW 1/4 FT10 not shown

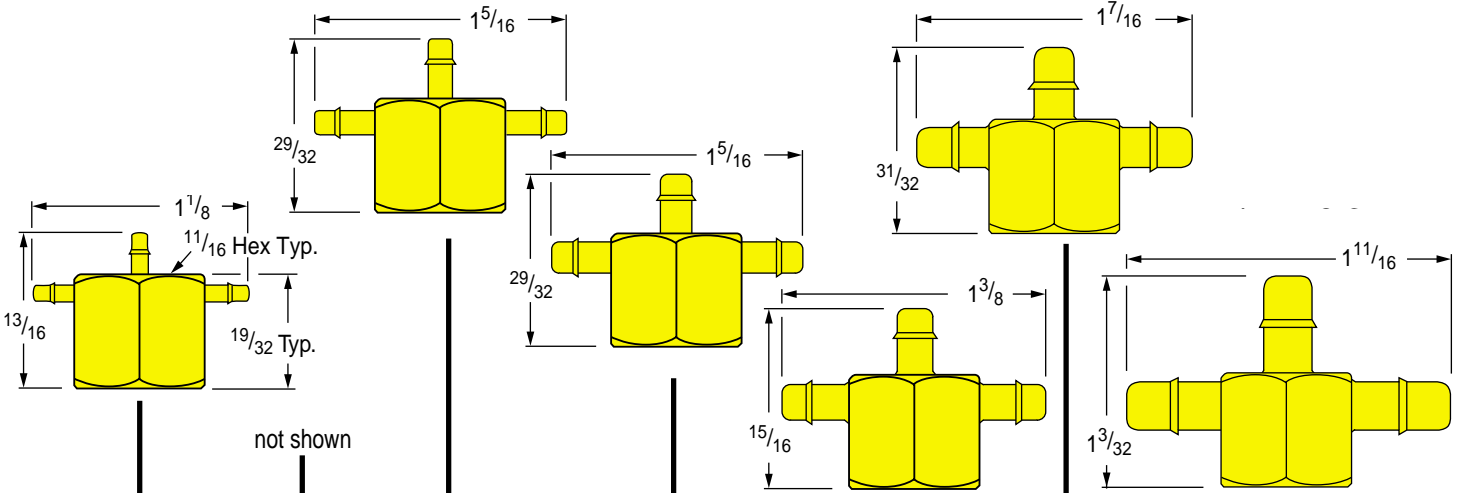

67 1/4 FT2 x 3 1/4 FT2 1/2 x 3 1/4 FT3 x 3 1/4 FT3 1/2 x 3 (4mm) 1/4 FT4 x 3 1/4 FT5 x 3 1/4 FT6 x 3

Bulkhead Fittings

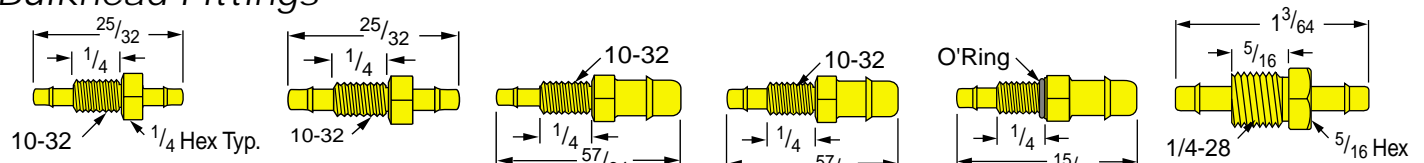

68 10 BK-1 or 10BK-2 10 BK-2 1/2 10 RBK4-2 10 RBK4-2 1/2 10 RBK-O-4-2 1/2 1/4 BK-3

Bulkhead Fittings

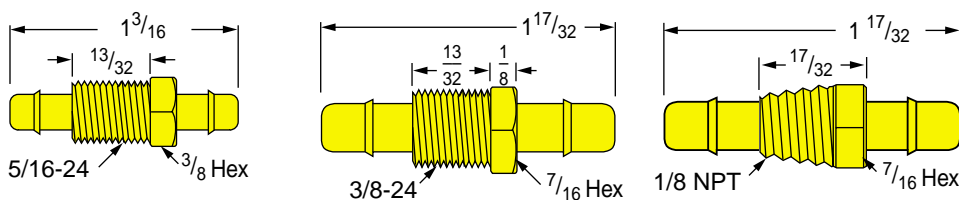

5/16 BK-4

3/8 BK-6

1/8 NPT BK6

69

L-Bulkhead Fittings *Note: Also available in Tee and Vee combinations*

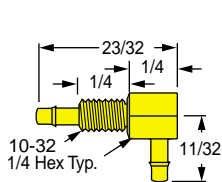

#1, #2, or #2-1/2 Barbs per part numbers below

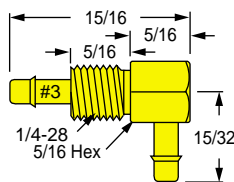

#3, #3-1/2, or #4 Barbs per part numbers below

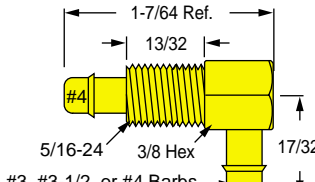

#3, #3-1/2, or #4 Barbs per part numbers below

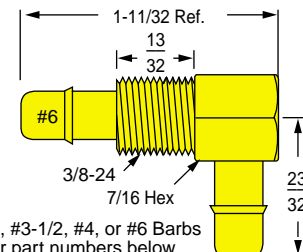

#3, #3-1/2, #4, or #6 Barbs per part numbers below

10BK1-L1
10BK2-L2
10BK2¹/₂-L2¹/₂

1/4 BK3-L3
1/4 RBK3-L3¹/₂
1/4 RBK3-L4

5/16 BK4-L4
5/16 RBK4-L3¹/₂
5/16 RBK4-L3

3/8 BK6-L6
3/8 RBK6-L4
3/8 RBK6-L3¹/₂
3/8 RBK6-L3

70

Reducing Bushings

Note: See page 23, Line #95 for additional multi-hole 10-32 bushings – sizes 1/8 and 1/4 Elbows, L-Tees, and Tees

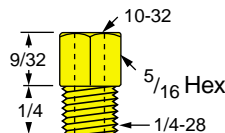
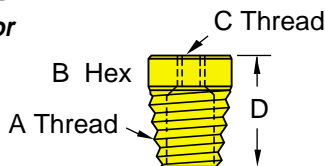

RB 4-28-10

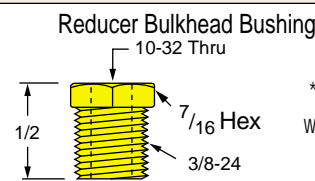

* RBB 3/8-10

* Lock nut and washer included

71

Reducer Bushing Dimensions

A Thread	1/4 NPT	1/4 NPT	1/4 NPT	1/4 NPT	1/4 NPT	1/4 NPT	1/8 NPT	1/8 NPT	1/16 NPT	1/4-28	3/8-24
B Hex	9/16	9/16	9/16	9/16	9/16	9/16	7/16	7/16	5/16	5/16	7/16
C Thread	10-32	10-32	1/16 NPT	1/8 NPT	1/16 NPT	1/8 NPT	10-32	1/16 NPT	10-32	10-32	10-32
D Height	3/4	1/2	1/2	1/2	3/4	3/4	9/16	9/16	17/32	17/32	1/2

Part #	RB 1/4-10	RB 1/4-10 Short	RB 1/4-1/16 Short	RB 1/4-1/8 short	RB 1/4-1/16	RB 1/4-1/8	RB 1/8-10	RB 1/8-1/16	RB 1/16-10	RB 428-10	RBB3/8-10	72
--------	-----------	-----------------	-------------------	------------------	-------------	------------	-----------	-------------	------------	-----------	-----------	----

Caps & Swivel Nipple

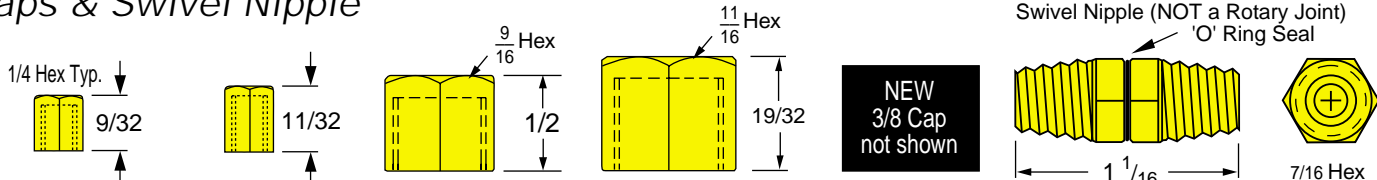

10-32 Cap (Short)

#10-32 Cap

1/8 Cap

1/4 Cap

NEW
3/8 Cap
not shown

3/8 Cap

1/8 SN

73

Plugs

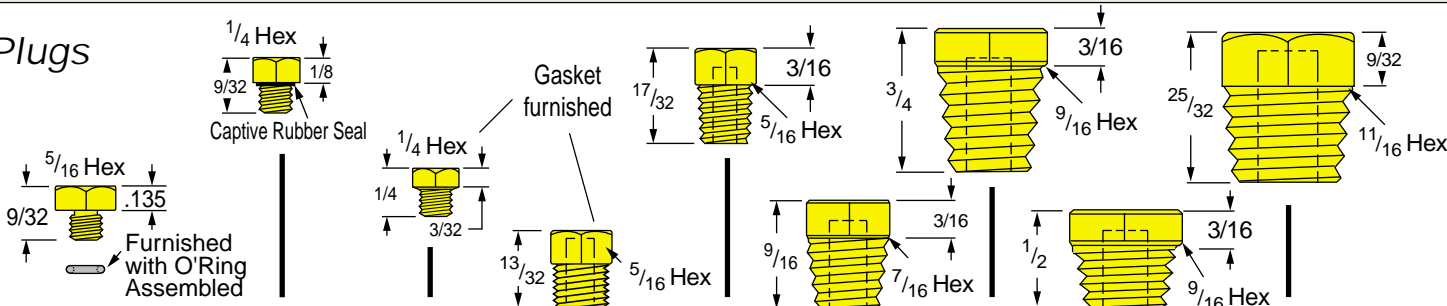

10-0 Plug

10-0-1/4 Plug

10-32 Plug

4-28 Plug

1/16 Plug

1/8 Plug

1/4 Plug

1/4 Plug (Short)

3/8 Plug

74

PTF Series Ferruleless Fittings

PTF (polytube fitting) terminations do not require ferrules to achieve a secure connection, which makes them easier to use and reuse. PTF fittings are designed for semirigid tubing, i.e., polyethylene, nylon, polyurethane, etc.

PTF fittings come standard in brass but can be electroless nickel plated brass at no extra charge. Some part numbers are available in Delrin® and all part numbers can be made in stainless steel. Knurled fitting nuts for both Delrin® and stainless steel fittings are usually made of brass because the nuts are non wetted parts.



Tube to Male Thread

‡ NEW - PTF Fittings are now available in polysulfone. Non-wetted knurled nuts are brass.

Tube O.D.	NPT	Male Part No.		Female Part No.		Flow					
		Delrin 250 PSI	Brass 1500 PSI	Delrin 250 PSI	Brass 1500 PSI	A	A2	B	C	D	E
.096	†10-32	‡	0015	‡	0015F	.400	.307	.250	.040	.093	.253
.140	†10-32	‡	0016	‡	0016F	.410	.317	.250	.070	.093	.253
1/8	†10-32	‡	0018	‡	0018F	.460	.367	.250	.062	.093	.253
1/4	†10-32	‡	0019	‡	0019F	.695	.570	.375	.093	.125	.285
1/8	1/16	‡	90329	‡	90329F	.495	.370	.437	.062	.125	.525
1/8	1/8	8671	2671	8671F	2671F	.495	.437	.062	.370	.125	.525
1/4	1/8	8673	2673	8673F	2673F	.675	.437	.156	.519	.156	.556
3/8	1/8	8675	2675	8675F	2675F	.890	.562	.187	.703	.187	.587
1/4	1/4	8679	2679	8679F	2679F	.705	.562	.156	.518	.187	.780
3/8	1/4	8681	2681	8681F	2681F	.890	.562	.518	.228†	.780	
1/4	3/8	8685‡	2685‡	8685F‡	2685F	‡	‡	‡	‡	‡	‡
3/8	3/8	8687‡	2687‡	8687F‡	2687F	‡	‡	‡	‡	‡	‡
1/2	3/8	8688‡	2688‡	8688F‡	2688F	‡	‡	‡	‡	‡	‡
1/2	1/2	8694‡	2694‡	8694F‡	2694F	‡	‡	‡	‡	‡	‡

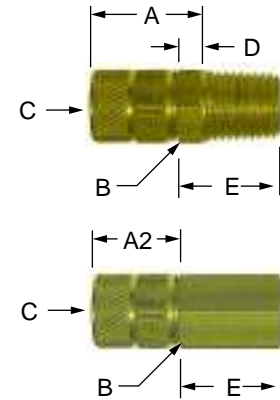

‡ Consult factory for pricing and availability
 † UNF straight threads pressure rating dependent on tubing characteristics

Knurled Nuts

Tube O.D.	Part Number Brass	Thread	A	B	Flow C
.096	3199	10-32	.330	.220	.100
.140	3200	12-28	.375	.250	.148
1/8	3201	10-32	.375	.250	.128
1/4	3203	3/8-24	.530	.437	.255
3/8	3205	1/2-24	‡	‡	‡
1/2	3206	5/8-20	‡	‡	‡

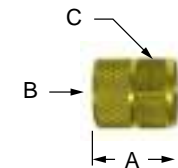

‡ Consult factory for pricing and availability

Tube to Tube

Tube O.D.	Tube O.D.	Part Number Brass	A	B	Flow C
.096	.096	92830	.750	.250	.040
.096	.140	92831	.750	.250	.040
.125	.125	0021	.875	.250	.062
.140	.140	92832	.750	.250	.070
.140	.250	92833	.990	.437	.070
.250	.250	20008	1.190	.437	.156

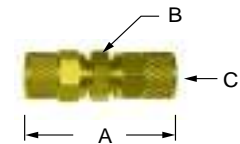

Miniature Bulkhead - Female Thread to Tube

Part Number	HEX	A	B	C (Flow)	D Thr'd
0019 BK	.437	.406	1.46	.156	10-32

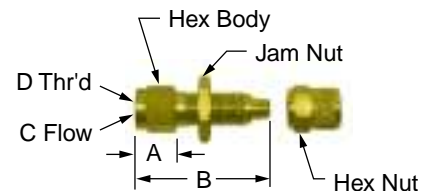

M3 x 0.5 Series Fibre Gasket Supplied

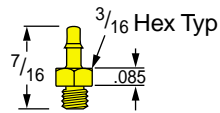

M3-B1

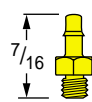

M3-B2

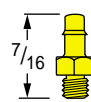

M3-B2 1/2

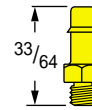

M3-B3

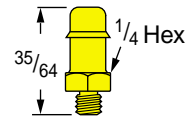

M3-B4

75

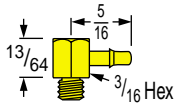

M3-LB1

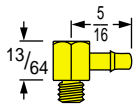

M3-LB2

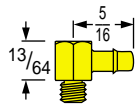

M3-LB2 1/2

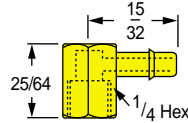

M3F-LB3

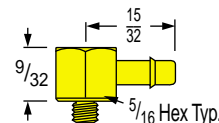

M3-LB3

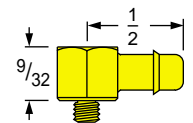

M3-LB4

76

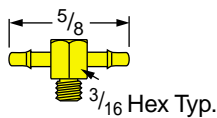

M3-T1

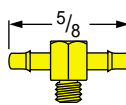

M3-T2

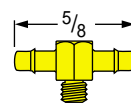

M3-T2 1/2

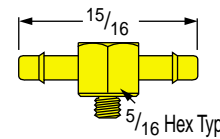

M3-T3

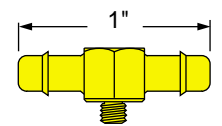

M3-T4

77

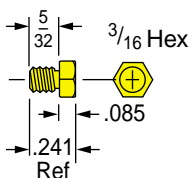

M3 Plain Plug

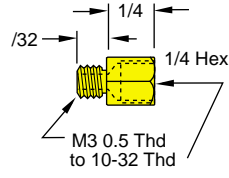

M3 x 0.5 to 10-32 (F) Adapter

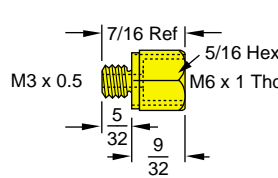

M3 x 0.5 to M6 x 1 (F) Adapter

See complete selection of adapters on pages 23 & 24

78

M5 x 0.8 Series Fibre Gasket Supplied

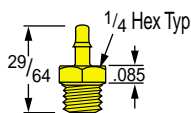

M5-B1

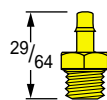

M5-B2

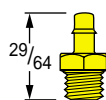

M5-B2 1/2

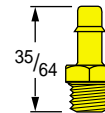

M5-B3

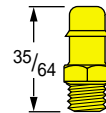

M5-B4

79

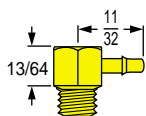

M5-LB1

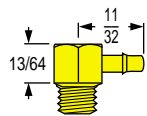

M5-LB2

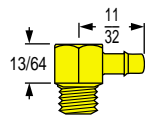

M5-LB2 1/2

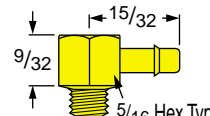

M5-LB3

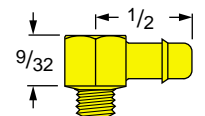

M5-LB4

80

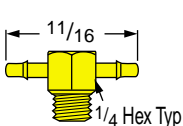

M5-T1

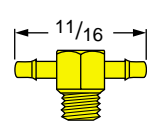

M5-T2

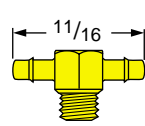

M5-T2 1/2

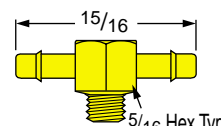

M5-T3

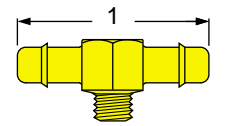

M5-T4

81

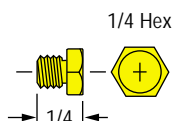

M5 Plain Plug

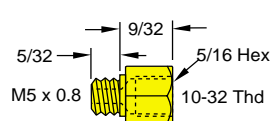

M5 x 0.8 to 10-32 (F) Adapter

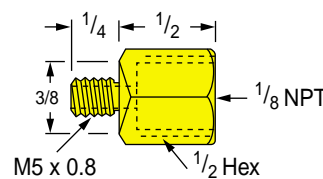

M5 x 0.8 to 1/8 (F) Adapter

See complete selection of adapters on pages 23 & 24

82

M6 x 1 Series

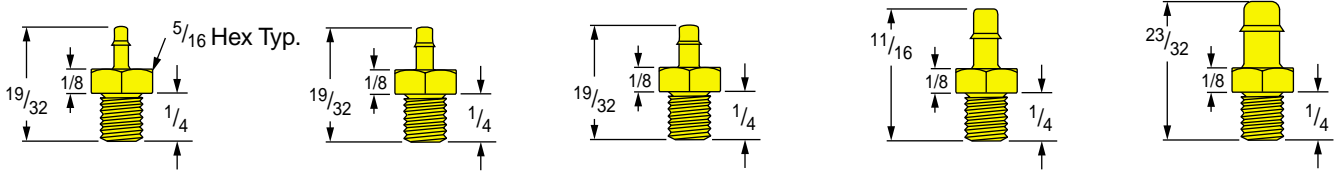

83 M6-B1 M6-B2 M6-B2 1/2 M6-B3 M6-B4

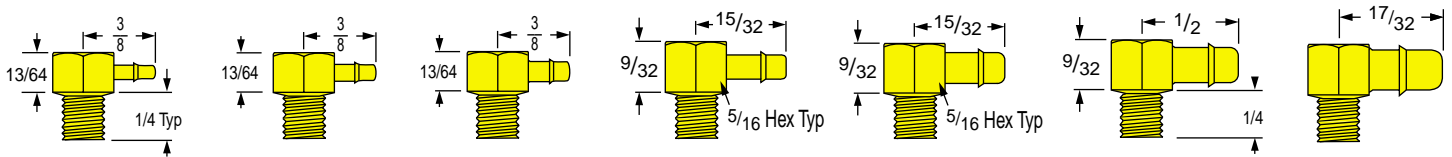

84 M6-LB1 M6-LB2 M6-LB2 1/2 M6-LB3 M6-LB3 1/2 M6-LB4 M6-LB5

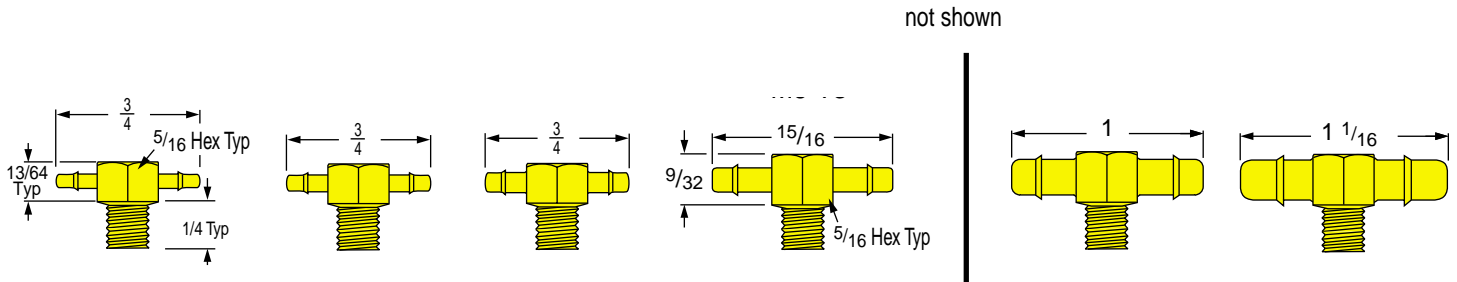

85 M6-T1 M6-T2 M6-T2 1/2 M6-T3 M6-T3 1/2 M6-T4 M6-T5

See complete selection of adapters on pages 23 & 24

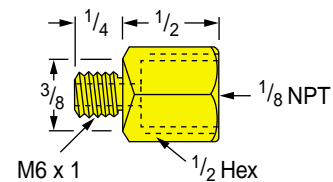
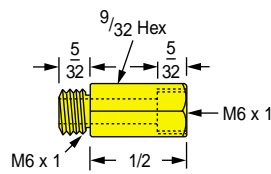
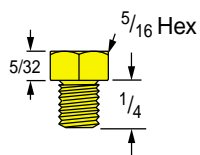

86 M6 Plain Plug M6 x 1 Male to Female Extension M6 x 1 to 1/8 (F) Adapter

Any fitting shown in this catalog is also available in Stainless Steel!

All of the brass fittings in this catalog are available in stainless steel. 303 stainless is standard; 316 is optional.

Passivation, oxygen cleaning, and electro-polishing are also available for your stainless fittings.

To order, add the suffix "S/S" to the brass part number and note any variations from standard.

Ordering Example

Brass Part Number 1/4 BK-3	Stainless Part Number 1/4 BK-3 S/S

Typical Stainless Steel Fittings

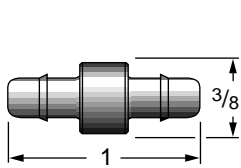

C5 S/S

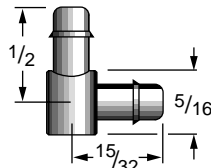

L4 S/S

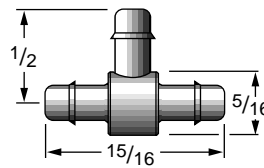

T4 S/S

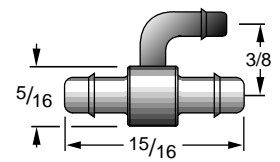

RT4-3L-4 S/S

Note: Mem-co makes a greater variety of female thread-to-tube fittings than any one else in the world!

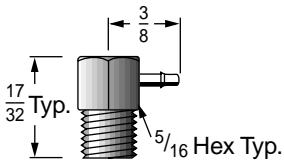

4-28 LB1 S/S

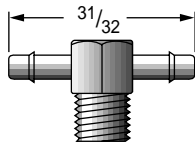

4-28 T3 S/S

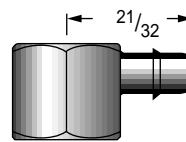

1/8 FLB5 S/S

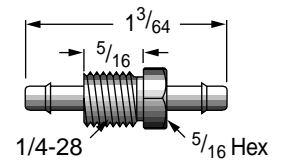

1/4 BK-3 S/S

Mem-co now makes 45° elbows in any combination

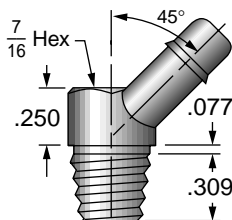

1/8 LB6-45° S/S

Stainless Steel Specials

No one in the world makes special fittings like Mem-co's. We welcome your requests for specials in brass, aluminum, and stainless steel. We look forward to helping you make the best connections possible!

Special stainless steel tube-to-tube manifold

Adapters

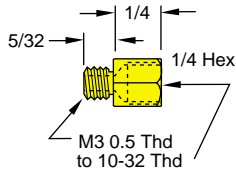

87 M3 to 10-32 (F)

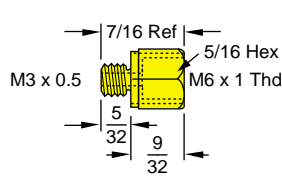

M3 to M6 (F)

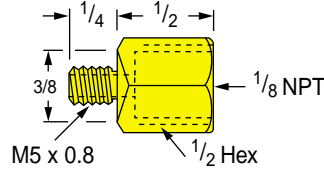

M5 to 1/8 (F)

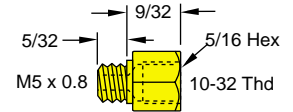

M5 to 10-32 (F)

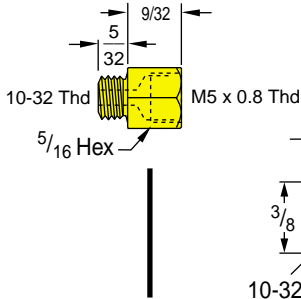

88 10-32 to M5 (F)

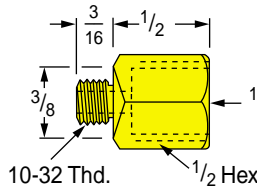

10-32 to 1/8 (F)

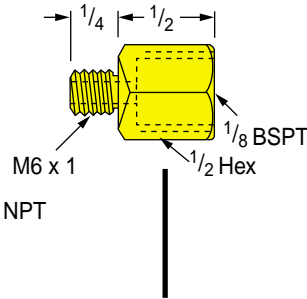

M6 to 1/8 BSPT (F)

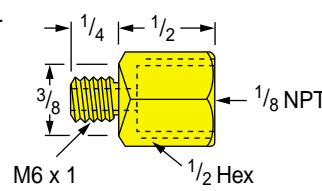

M6 to 1/8 (F)

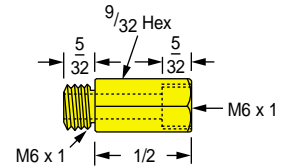

EX-M6 (M-F)

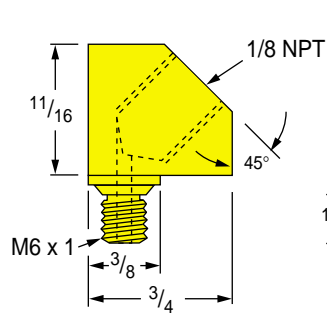

89 M6 to 1/8 (F) 45°

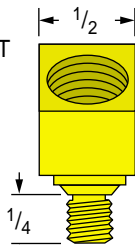

M8 to 10-32 (F)

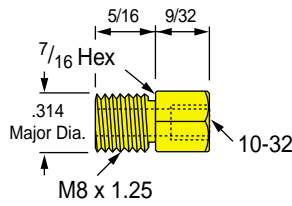

M8 to 1/8 (F)

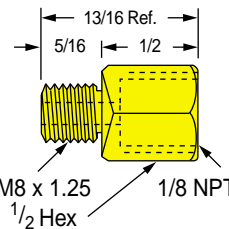

M8 to 1/8-28 BSPP (F)

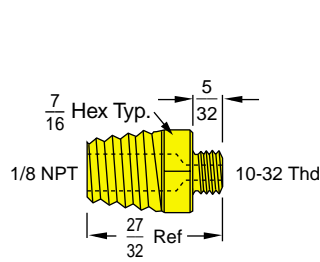

90 AN 1/8 to 10-32

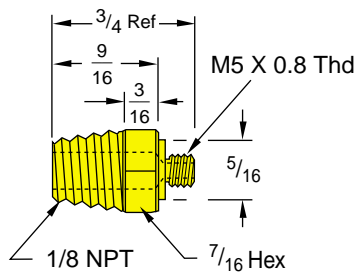

AN 1/8 to M5

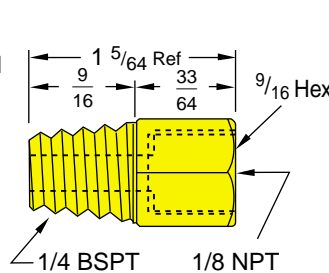

1/4 BSPT to 1/8 (F)

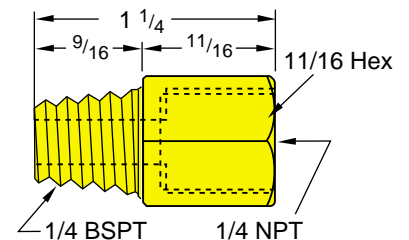

1/4 BSPT to 1/4 (F)

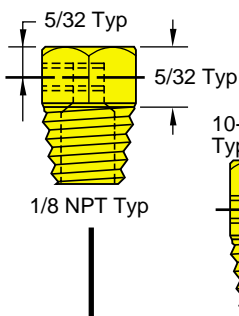

91 1/8L-10F

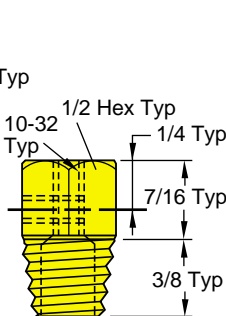

1/8LT-10F

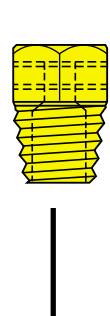

1/8T-10F

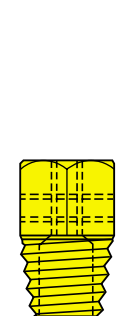

1/8T-10F x 3



1/4L-10F

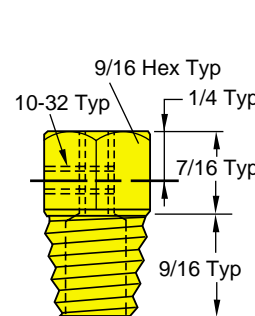

1/4LT-10F

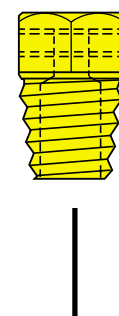

1/4T-10F

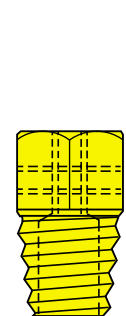

1/4T-10F x 3

90° L Adapters – Male to Female

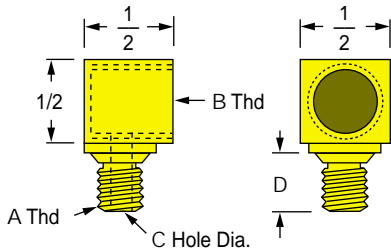

Part No.	A Thd	B Thd	C Dia	D	Line No.
M8 to 1/8FL	M8x1.25	1/8 NPT			92
M8 to M8FL	M8x1.25	M8x1.25			93
M8 to M6FL	M8x1.25	M6x1			94
M8 to M5FL	M8x1.25	M5x0.8	5/32	5/16	95
M8 to M3FL	M8x1.25	M3x0.5			96
M8 to 1/4-28FL	M8x1.25	1/4-28			97
M8 to 10-32FL	M8x1.25	10-32			98
M6 to 1/8FL	M6x1	1/8 NPT			99
M6 to M8FL	M6x1	M8x1.25			100
M6 to M6FL	M6x1	M6x1			101
M6 to M5FL	M6x1	M5x0.8	5/64	1/4	102
M6 to M3FL	M6x1	M3x0.5			103
M6 to 1/4-28FL	M6x1	1/4-28			104
M6 to 10-32FL	M6x1	10-32			105
M5 to 1/8FL	M5x0.8	1/8 NPT			106
M5 to M8FL	M5x0.8	M8x1.25			107
M5 to M6FL	M5x0.8	M6x1			108
M5 to M5FL	M5x0.8	M5x0.8	.089	1/4	109
M5 to M3FL	M5x0.8	M3x0.5			110
M5 to 1/4-28FL	M5x0.8	1/4-28			111
M5 to 10-32FL	M5x0.8	10-32			112
1/8 to 1/8FL	1/8 NPT	1/8 NPT			113
1/8 to M8FL	1/8 NPT	M8x1.25			114
1/8 to M6FL	1/8 NPT	M6x1			115
1/8 to M5FL	1/8 NPT	M5x0.8	1/4	1/2	116
1/8 to M3FL	1/8 NPT	M3x0.5			117
1/8 to 1/4-28FL	1/8 NPT	1/4-28			118
1/8 to 10-32FL	1/8 NPT	10-32			119

Orifice Couplings have through holes drilled to exact diameters specified in inches.

Line Number 124

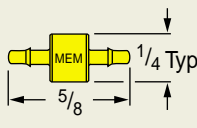

Orifice	Part No.
.005"	C1-OR-.005
.006"	C1-OR-.006
.007"	C1-OR-.007
.008"	C1-OR-.008
.009"	C1-OR-.009
.010"	C1-OR-.010
.011"	C1-OR-.011
.012"	C1-OR-.012
.013"	C1-OR-.013
.014"	C1-OR-.014
.015"	C1-OR-.015
.016"	C1-OR-.016
.017"	C1-OR-.017
.018"	C1-OR-.018
.019"	C1-OR-.019
.020"	C1-OR-.020
.025"	C1-OR-.025
.030"	C1-OR-.030
.040"	C1-OR-.040

Line Number 125

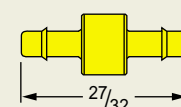

Orifice	Part No.
.005"	C3-OR-.005
.006"	C3-OR-.006
.007"	C3-OR-.007
.008"	C3-OR-.008
.009"	C3-OR-.009
.010"	C3-OR-.010
.011"	C3-OR-.011
.012"	C3-OR-.012
.013"	C3-OR-.013
.014"	C3-OR-.014
.015"	C3-OR-.015
.016"	C3-OR-.016
.017"	C3-OR-.017
.018"	C3-OR-.018
.019"	C3-OR-.019
.020"	C3-OR-.020
.025"	C3-OR-.025
.030"	C3-OR-.030
.040"	C3-OR-.040

Line Number 126

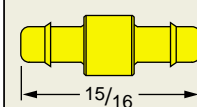

Orifice	Part No.
.025"	C4-OR-.025

Note:
The general dimensions in this catalog are subject to change without notice.



F Series Brass Barbed Fittings

Single barb allows tubing to flow around it.

Tapers facilitate assembly.

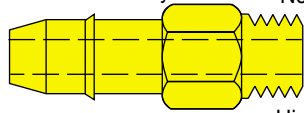

No Undercut

Sharp edge "bites" into tubing

High Strength

MEM-CO's unique single barb design provides superior resistance to "Tubing Pull-Off". Additionally, the threaded fittings are produced without any undercut at the thread base. This results in a fitting with superior strength. The fittings can be locked firmly in place using a thread sealant and can be removed, if necessary, without heating or breakage.

Thread Sealant-No Gasket Assembly

Any "L", "T", or "X" fitting can be aimed in the needed direction, rather than chancing a broken gasket from over-tightening or leakage from under-tightening.

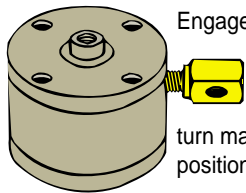

Engage the fitting 1/2 to 1 turn. Apply a drop of Loctite® at junction. Tighten fully by hand then back off (1 full turn max.) if needed for desired position. Allow the Loctite® to cure.

Recommended Loctite® anaerobic sealants

Number	Color	Approximate Cure time
RC/609	Green	1 – 6 hours
290 (wicking)	Green	1 – 2 hours

Note: It is recommended that Loctite® Primer be used on the male thread before installing. This shortens handling and cure time. Low temperature heat, such as sunshine or heat from a light bulb can also be used to speed curing.

Loctite® is a registered trademark of Loctite Corp.

Use wire or similar object to apply a drop of Loctite®.

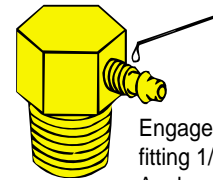

Engage the barbed fitting 1/2 to 1 turn. Apply a drop of Loctite® at junction. Finish threading the fitting into the hole. Allow the Loctite® to cure.

Flanged Locking Sleeves - Sleeves are packed 100 per package



Sleeves quickly and firmly lock 1/4" O.D. tubing to barbed fittings. Eliminates maintenance problems caused by tubing stretch and enlargement. To install, place sleeve over tubing as shown. Install hose over fitting as usual. Slide sleeve over hose until it covers barbed area of fitting.

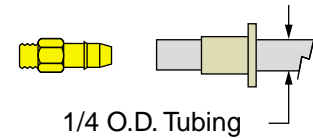

1/4 O.D. Tubing

120 S-14

#1 and #3 Barbed Fittings

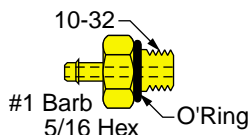

10-32
#1 Barb
5/16 Hex
O'Ring
Buna-N O'Ring face seal, installed.

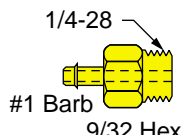

1/4-28
#1 Barb
9/32 Hex
Use Thread Sealant. No Gasket Assembly.

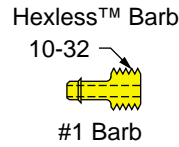

Hexless™ Barb
10-32
#1 Barb
Use Thread Sealant. No Gasket Assembly.

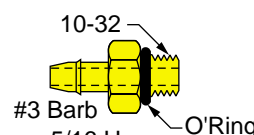

10-32
#3 Barb
5/16 Hex
O'Ring
Buna-N O'Ring face seal, installed.

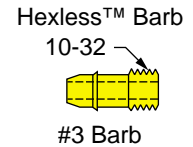

Hexless™ Barb
10-32
#3 Barb
Use Thread Sealant. No Gasket Assembly.

121 B1-O (Old No. 1016-O) 4-28 B1 (Old No. 1416) BA1 (Old No. 3216) B3 (Old No. 1017) BA3 (Old No. 3217)

#4 Barbed Fittings

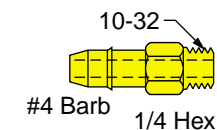

10-32
#4 Barb
1/4 Hex
Includes GA-10 gasket.

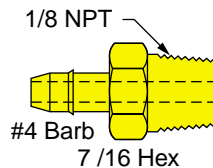

1/8 NPT
#4 Barb
7/16 Hex

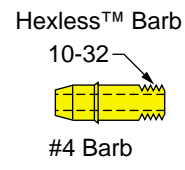

Hexless™ Barb
10-32
#4 Barb
Use Thread Sealant. No Gasket Assembly.

122 B4 (Old No. 1014 & 1014-1) 1/8 B4 (Old No. 1814) BA4 (Old No. 3214 & 3214-1)

10-32 Female to Female Fittings - See "Thread Sealant-No Gasket Assembly" on page 25.

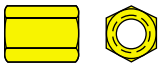

Coupling 1/4" Hex

1020



"L" Elbow 3/8" Square

FL-10

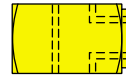

"T" Tee 3/8" Square

FT-10

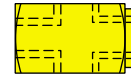

"X" Cross 3/8" Square

FX-10

123

10-32 Male to Female Fittings - See "Thread Sealant-No Gasket Assembly" on page 25

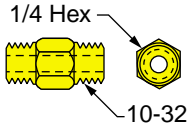

Nipple 1/4" Hex

1010

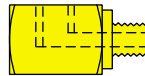

"L" Elbow 3/8" Square

ML-10

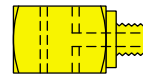

"T" Tee 3/8" Square

MT-10

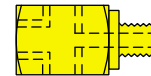

"X" Cross 3/8" Square

MX-10

124

1/8 NPT Male to 10-32 Female Fittings

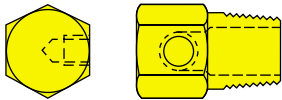

"L" Elbow 7/16" Hex

1820

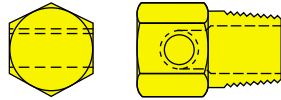

"T" Tee 7/16" Hex

1830

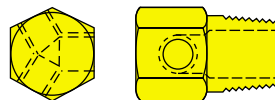

3 Way 7/16" Hex

1840

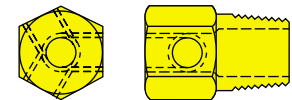

4 Way 7/16" Hex

1850

125

1/4 NPT Male to 10-32 Female Fittings

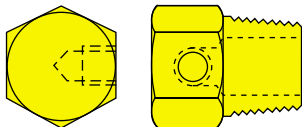

"L" Elbow 9/16" Hex

1420

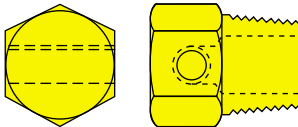

"T" Tee 9/16" Hex

1430

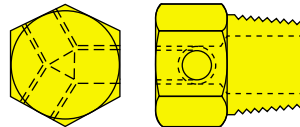

3 Way 9/16" Hex

1440

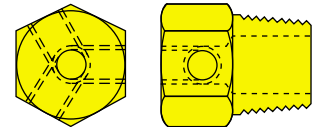

4 Way 9/16" Hex

1450

126

Reducer Fittings

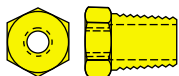

1/16 NPT to 10-32; 3/8" Hex

1610

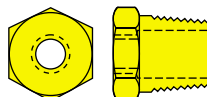

1/8 NPT to 10-32; 7/16" Hex

1810

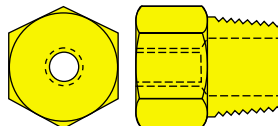

1/4 NPT to 10-32; 9/16" Hex

1410

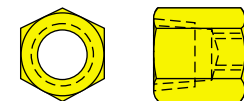

1/8 NPT to 10-32; 7/16" Hex

1860

127

10-32 Swivel Fittings - with GA-10 Gasket.

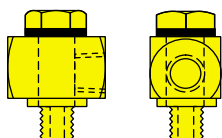

SFL-10
"L" Elbow

SFL-10

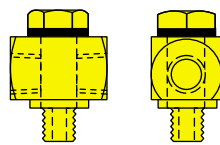

SFT-10
"T" Tee

SFT-10

10-32 Plug

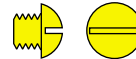

Material: Plated Steel
10 per package with
GA-10 Gaskets

P-10

Gasket
for 10-32 Fittings.
100 per package.



Material: 1/32" Thick Fiber

GA-10

128

Tube to Tube Manifold
Stainless Steel
 (Also available in brass)

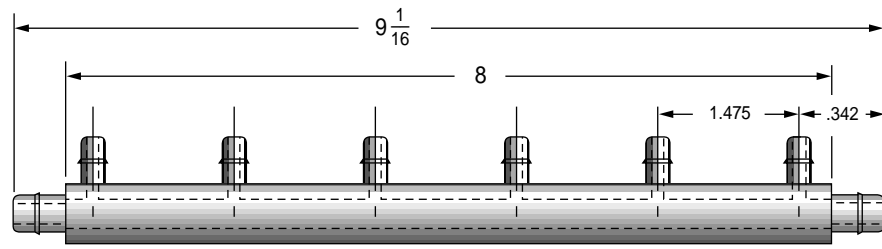

5/8 x 5/32 wall – 304 Stainless Steel Tubing (Scale 2:1)

129

Manifold 8-6x6-8 (also available in brass)

F Series 10-32 Manifold
4 Outlets - 1/8 NPT Inlet
 (Black anodized aluminum)

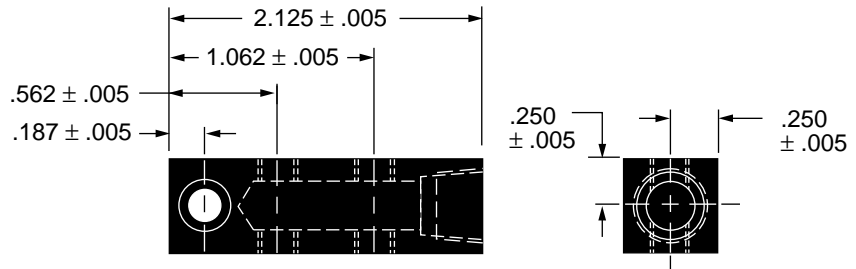

130

M-4

F Series 10-32 Manifold
6 Outlets - 1/8 NPT Inlet
 (Black anodized aluminum)

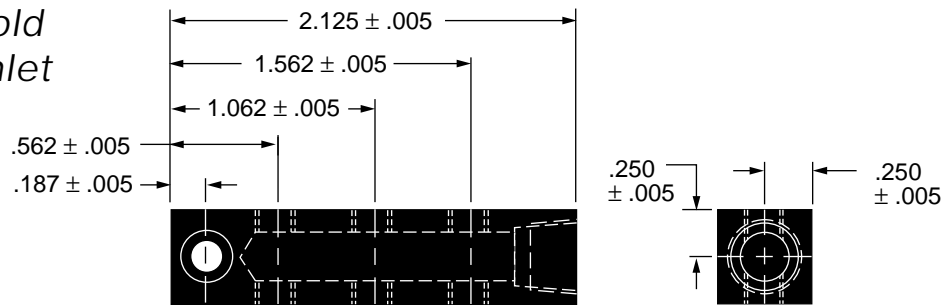

131

M-6

F Series 10-32 Manifold
8 Outlets - 1/8 NPT Inlet
 (Black anodized aluminum)

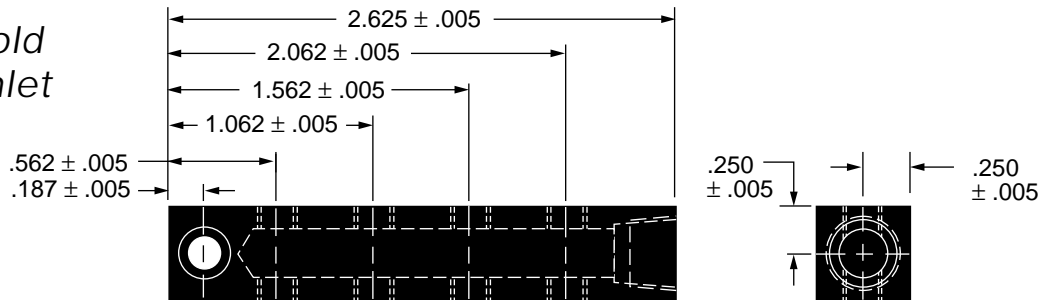

132

M-8

F Series 10-32 Manifold
12 Outlets - 1/8 NPT Inlet
 (Black anodized aluminum)

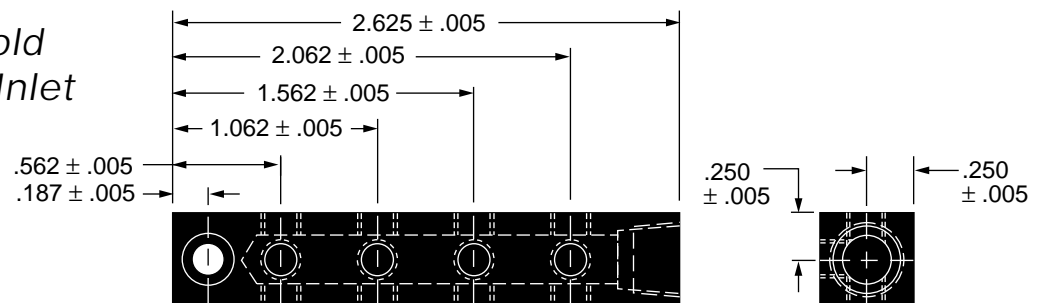

133

M-12

1/8 Male Pipe Thread Manifold Fittings

Branches can be arranged in various attitudes in thousands of combinations to accommodate specific requirements.

Mem-co's line of Unitized Manifold Fittings is directed primarily at the high volume user who must have a • low cost • compact • zero leak potential • neat appearing fitting that requires a minimum amount of labor to install and can be customized to his specific requirements.

For smaller volume users Mem-co does carry a limited number of manifold fittings as stock items shown below.

Manifold Fitting Nomenclature

- 1/8 M = 1/8 Male NPT one end & branch outlets as required
- 1/8MM = 1/8 Male NPT and mixed branches
- 1/8MV = 1/8 Male NPT and 2nd row at 60° either L or R
- 1/8MMV = 1/8 Male NPT w/mixed branches at 60° either L or R
- 1/8MT = 1/8 Male NPT with branches at 180°
- 1/8MMT = 1/8 Male NPT w/mixed branches at 180°
- 1/8MB = 1/8 Male NPT Manifold blank
(wall thickness suitable for 10-32 thread)

Tell us what you need

Branch sizes are called out in order starting at the threaded end. **1/8MM-44222** (Figure 1) signifies a mixed manifold 1/8 NPT fitting with two #4 branches and three #2 branches in-line.

1/8MM-42422 signifies a similar manifold on which the 2nd and 3rd branches have exchanged positions.

In the case of "V" arrangements, the side having the largest branches is considered to be the vertical side (at 12 o'clock); the other side is either to the right or left of vertical as viewed from the threaded end of the fitting.

1/8MMV-44-22L (Figure 2) signifies a "V" type 1/8 NPT manifold fitting with two #4 branches and two #2 branches on each row with the second row to the right as viewed from the threaded end.

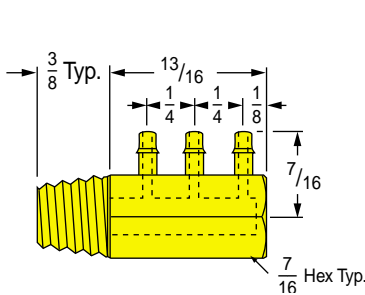

1/8 M-111 or 1/8 M-222

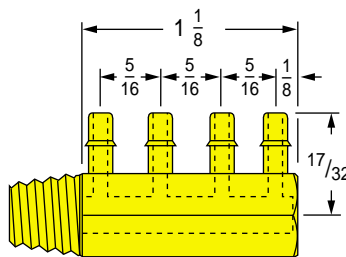

1/8 M-3333

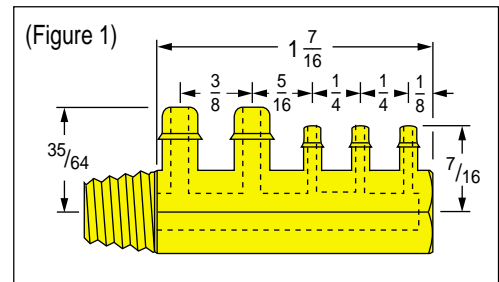

1/8 MM-44222

134

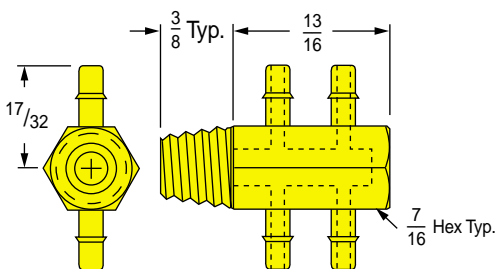

1/8 MT-33-33

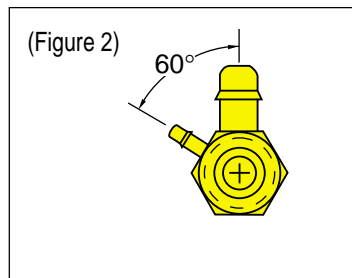

1/8 MMV-44-22L

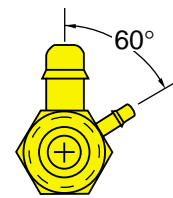

1/8 MMV-444-222R

135

1/8 Male Pipe Thread Manifold Blanks - will accommodate 10-32 thread

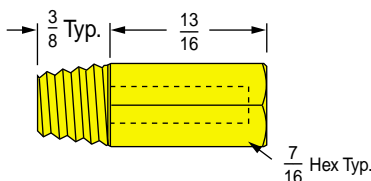

1/8 MB 13/16

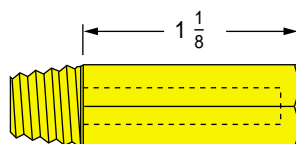

1/8 MB 1-1/8

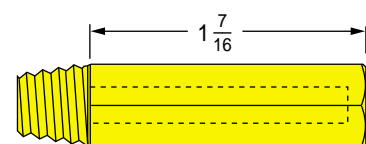

1/8 MB 1-7/16

136

Manifolds Made From a Variety of Materials

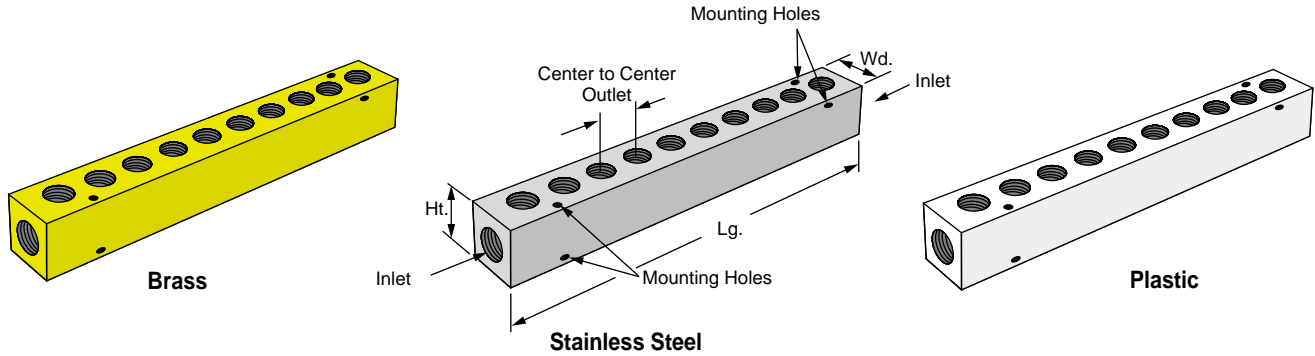

Manifold Dimensions (Inches)								
No. of Outlets	Inlet Pipe Size	Outlet Pipe Size	Brass Lg.	Wd.	Ht.	Outlet Ctr. to Ctr.	Mtg. Hole Ctr. to Ctr.	Mtg. Hole Size
2	1/4	1/8	1-3/4	1	1	3/4	-	0.17
	3/8	1/4	2-3/8	1-1/4	1-1/4	7/8	-	0.20
	1/2	3/8	2-3/4	1-1/2	1-1/2	1	-	0.20
4	1/4	1/8	3-1/4	1	1	3/4	1-1/2	0.17
	3/8	1/4	4-1/8	1-1/4	1-1/4	7/8	1-3/4	0.20
	1/2	3/8	4-3/4	1-1/2	1-1/2	1	2	0.20
6	1/4	1/8	4-3/4	1	1	3/4	3	0.17
	3/8	1/4	5-7/8	1-1/4	1-1/4	7/8	3-1/2	0.20
	1/2	3/8	6-3/4	1-1/2	1-1/2	1	4	0.20
8	1/4	1/8	6-1/4	1	1	3/4	4-1/2	0.17
	3/8	1/4	7-5/8	1-1/4	1-1/4	7/8	5-1/4	0.20
	1/2	3/8	8-3/4	1-1/2	1-1/2	1	6	0.20
10	1/4	1/8	7-3/4	1	1	3/4	6	0.17
	3/8	1/4	9-3/8	1-1/4	1-1/4	7/8	7	0.20
	1/2	3/8	10-3/4	1-1/2	1-1/2	1	8	0.20

How to Order

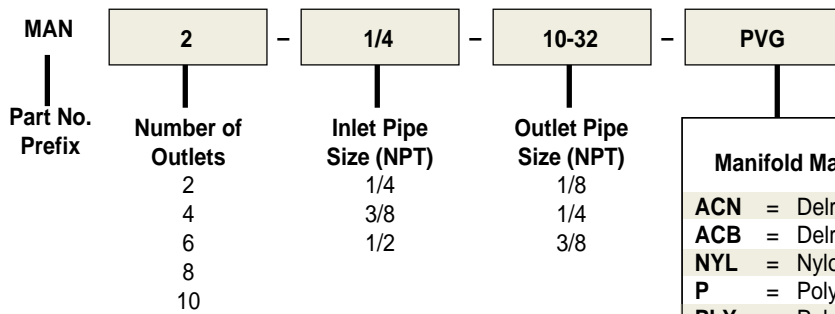

Ordering Example

MAN6 - 3/8 - 1/8 - ALN

The part number specifies a 6 outlet manifold with 3/8 NPT inlet ports and 1/8 NPT outlet ports.

Manifold Material	Temperature Range	Pressure Max PSI
ACN = Delrin Natural	-20° to + 180°F	200
ACB = Delrin Black	-20° to + 180°F	200
NYL = Nylon	-60° to + 100°F	200
P = Polypropylene	+32° to + 210°F	150
PLY = Polypropylene Black	+32° to + 210°F	150
PVD = PVDF	-65° to + 230°F	150
PVG = PVC Gray	+32° to + 140°F	150
PWF = PVC White	+32° to + 140°F	150
TEF = PTFE	-20° to + 180°F	120
ALB = Aluminum - BSPP (6061 Clear Anodized)	+300° to + 400°F	1,000
ALP = Aluminum - BSPT (6061 Clear Anodized)	-65° to + 250°F	1,000
ALN = Aluminum (6061 Black Anodized)	-65° to + 250°F	1,000
BR = 360 Brass	-65° to + 250°F	2,000
SS303 = 303 Stainless Steel	-65° to + 250°F	3,500
SS304 = 304 Stainless Steel	-65° to + 250°F	3,500
SS316 = 316 Stainless Steel	-65° to + 250°F	3,500

3-56 Male Thread to Tube Fibre Gasket Supplied



3-56B1*

3-56B2*

3-56B3*

137

6-32 Male Thread to Tube Fibre Gasket Supplied

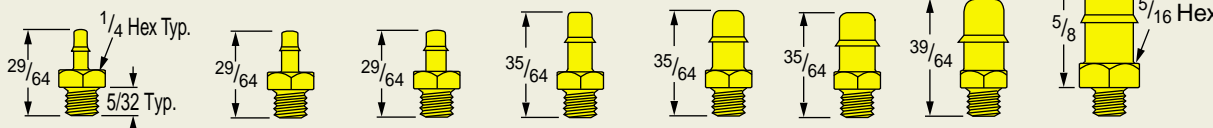

6-32B1*

6-32B2*

6-32B2^{1/2}*

6-32B3

6-32B3^{1/2} (4mm)

6-32B4

6-32B5

6-32B6

6-32B7-0 (8mm) 138

NEW
6-32B7-0
Not Shown

8-32 Male Thread to Tube Fibre Gasket Supplied

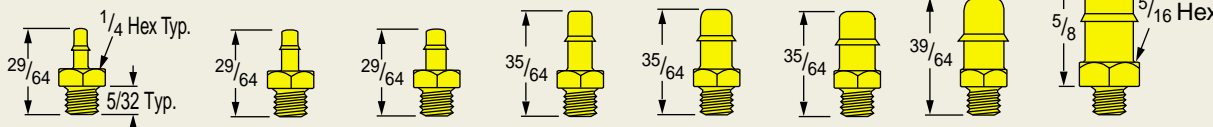

8-32B1*

8-32B2*

8-32B2^{1/2}*

8-32B3

8-32B3^{1/2} (4mm)

8-32B4

8-32B5

8-32B6

8-32B7-0 (8mm) 139

NEW
8-32B7-0
Not Shown

No one else in the world will make the specials that Mem-co Makes!



1/8" male thread to an extended #6 barbs, stainless steel



Stainless steel manifold, four #4 barb tube-to-tube connections



Tube-to-tube manifold, #6 inlet to #3 outlets, electroless nickel plated brass



Unique manifold, 1/2" male inlet to nine #2 barbs, electroless nickel plated brass



Special manifold, 1/8" female inlet, two 10-32 female outlets, six #3 barb outlets, and one #10 outlet; electroless nickel plated brass



PTF Series, 1/4" male thread (Delrin®) to tube (brass)

May we help with your special requirements?

Special Socket Set for Mem-co Threaded Fittings

Benefits - Packed in a transparent case of extra strength "K" resin, these are the correct tools for a faster and safer way to install Mem-co threaded fittings - especially the elbows and tees.

Mem-co socket sets are manufactured with unique cut-outs to clear the barbed branches. Using these special sockets not only speeds assembly, but also reduces the chance of damaging the branches as might happen when open-end or adjustable wrenches are employed in assembly.

These sockets also reduce the tendency to neglect that final little extra torque that ensures a tight seal. A shallow socket depth prevents any downward force being applied to a branch.



Five sizes are included in the set as follows:

1/4 Hex	6 point	1/4 drive
5/16 Hex	6 point	1/4 drive
7/16 Hex	6 point	1/4 drive
9/16 Hex	6 point	3/8 drive
11/16 Hex	6 point	3/8 drive

140

Order Model No. SWS

"Demountable" Cylinder rod alignment compensators (Patented)

A low cost coupler for small bore cylinders having threaded rods 10-32 thru 5/16-24

Benefits

MEM-CO's compensator is "DEMOUNTABLE", i.e. should it be necessary to remove the driven section or cylinder for servicing it is not necessary to detach our compensator. It merely slips apart thus maintaining original settings and adjustments. This feature is especially valuable in small air press applications where quick set up changes are needed.

It reduces wear on bearings due to misalignment of machine elements and cylinder shaft.

It prevents power loss in small cylinders caused by poor alignment or direction of machine components. This power loss can be a significant portion of total power of small cylinders.

Incorporating MEM-CO's compensators in machine design allows more flexibility in tolerances and choices of cylinder mounting.

Specifications

- Angular movement: 3° in any direction or a total of 6°
- Axial movement is a total of .020"
- Material is heat treated steel
- Thread sizes available: 10-32 1/4-28 5/16-24
- Thread depth 5/16"
- Combined length 1-3/8"
- Dimensions shown are the same for all thread sizes

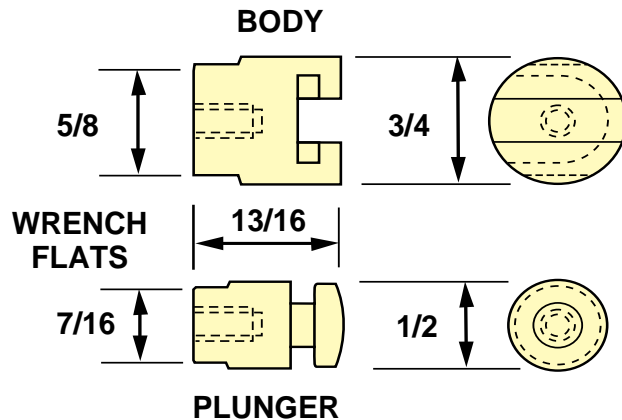

Model Number	Thread Size	Model Number	Thread Size	Model Number	Thread Size
141	RAC 332 10-32	RAC 428	1/4-28	RAC524	5/16-24

Multiple Port Rotary Valve (Patented)

Methods of Actuation

■ **Manual operation** – the external actuator may be a knob or hand wheel attached to valve shaft.

■ **Remote operation** – an air or hydraulic cylinder or solenoid can index the valve via a ratchet mechanism attached to the valve shaft.

■ **Mechanical operation** – a cam on the main machine actuates the ratchet mechanism on the valve shaft.

How it works

Rotating the external actuator one position (clockwise or counterclockwise) directs air pressure to the next outlet port at the front of the unit. All other outlet ports are open to atmosphere. Thus, in the illustration above, a single acting cylinder can be actuated by connecting its port to any of the valve outlet ports. A double acting cylinder can be operated by connecting its ports to any two of the valve outlets. If connected to two adjacent outlets, the cylinder will open and close immediately on the next advancement of the actuator; if connected to nonadjacent outlets, the cylinder's extend/retract cycle can be sequenced with other operations controlled by the valve.

Manual Operation

Side view panel mounted– rotary valve is shown with knob attached to valve shaft. Valve is indexed by hand through 10 or 20 outlet ports depending on valve model.

Remote Operation

Front view base mounted

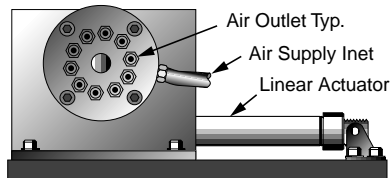

Rear view base mounted

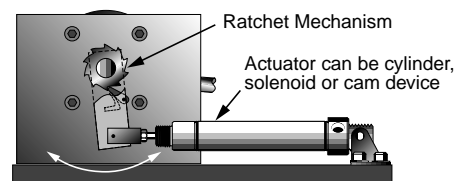

General Use

■ As a panel mounted selector valve for remote control of pneumatic cylinders, valves or other devices.

■ As a programmer for automatic machinery, (lathes, drilling machines, winders, etc.).

■ As an "IMPLANT" in a large machine to supply sequential control where indexing is accomplished by some moving part of the machine.

■ As a sampling device whereby a vacuum is employed to draw a sample of air from a controlled atmosphere area to a central analyzing station, and/or to check atmospheric pressure.

■ Units may be coupled in tandem (requires special shaft), or in series; i.e. a port on first unit is connected to actuator

device on second unit and a port on second unit is connected to actuator on third unit, etc., etc. In this fashion an infinite number of counts may be obtained.

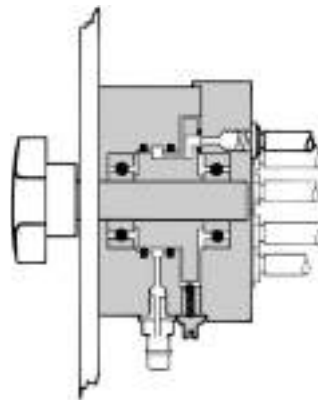
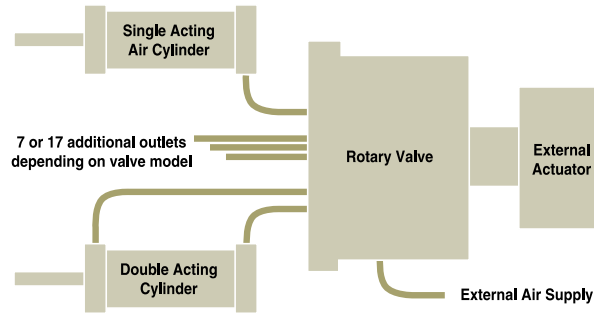

MODEL GV2-10 with 10 outlet ports is shown mounted on an angle bracket attached to machine base.

An air or hydraulic cylinder, a solenoid, or a cam on the main machine can index the valve via a ratchet mechanism attached to the valve shaft.

General Specifications

Model GV2-10/Model GV20

Number of outlet ports –

GV2-10 (10 outlets)

GV2-20 (20 outlets)

Outlet & Supply Ports – 10-32 thread

Air flow – 8.1 CFM at 100 psi to atmosphere

Detent – Spring loaded ball plunger

Rotation – left or right

Operating pressure range – 0 to 125 psi

Shut-off occurs between any two ports
(18° from detent)

Materials

Body – Aluminum

Rotor – Steel

Port cap – Steel

Shaft – 3/8" diameter steel

Bearings – Ball

Seals – Standard Buna N 'O' Ring

General valve dimensions

GV2-10: 2-3/8" dia. x 1-7/16" long

Shaft extension – 1"

Mounting – Four 8/32" tapped holes
on 1.950" bolt centers

GV2-20:

3-1/8" dia. x 1-7/16" long

Shaft extension – 1"

Mounting – Four 8/32" tapped holes
on 2.700" bolt centers

Servicing

One 9/64 hex wrench field strips valve for servicing.

Available Options

1. Basic valve (no actuator parts)

2. Basic valve with ratchet mechanism

3. Basic valve mounted to 3" x 8" aluminum base plate with ratchet mechanism and air cylinder

4. Basic valve with knob

Model Number 6 Outlets
GV2-6/6

Model Number 10 Outlets
GV2-10/10

Model Number 20 Outlets
GV2-20/20

MEM-CO

Since 1963. . . Mem-co has been the premier designer and manufacturer of high quality, miniature, barbed air and fluid fittings for science and industry. Mem-co Fittings feature flawless silver solder joints and are all 100% inspected.

Memco fittings are used in countless applications. . .

Semiconductor	Paint ball equipment
Automotive	Fuel / carburetor systems
Recreational vehicles	Ink jet engines
Amusement equipment	Homeland defense devices
Production machinery	Hydrogen fuel cells
Medical equipment	Hobby / models
Food packaging	Lasers
Instrumentation devices	Miniature jet engines
Military equipment	Laboratory equipment
Robots	Biomedical devices
Dental equipment	Aerospace equipment
Cooling & lubrication devices	Toxic gas detection equipment
Automated production equipment	Textile machinery
Pneumatic gauges	Transducers
Conveyor systems	and many more!

MEM-CO., Inc. • 45 Gigante Drive • Hampstead, NH 03841
Phone (603) 329-9633 • Fax (603) 329-46339
www.mem-co.com • Email: info@mem-co.com

